

Mid-States

MATERIAL HANDLING EQUIPMENT

40 PLUS
YEARS
LOGISTICS
LEADER



Move. Stack. Store.
CUSTOM DESIGN

Order from:
Dick Jones Sales, Inc.
258 Baltimore St. P.O. Box 141
Hanover, PA 17331-0141
P 800-441-9955
F 800-253-4036
dickjones@dickjonessales.com



Motorcycle Storage Rack



4 Wheel Double End Steer Trailer



Fifth Wheel Steer Trailer



Rotating Conveyor Deck Cart



Elevated, Rotating, Towable Delivery Cart



3-Level Kitting Cart



Returnable Shipping Skids



Warehousing Stack Racks



Bar Storage Cart



Dual Wheel Fifth Wheel Trailer



Mobile Stacking Frames



Security Truck



Wire Mesh Cart



Transport Cart



"U" Cart



Four Wheel Steer Train 1



Four Wheel Steer Train 2



Four Wheel Steer Train 3



Order Picker



Air Craft Support Cart



Dri Pak with Butterfly Valve



3 Level Order Picker Cart

Caster Steer Trailer

- Heavy duty steel frame with round corners
- Steel on hardwood kiln-dried deck
- Max. Speed 5mph

- Double Ball bearing swivel casters
- Roller bearing wheels
- Two Pockets on each end outside frame



307RR-2T-C7-C17

Standard deck sizes up to 48x96. Other sizes and capacities available upon request.

Mold-On Rubber Wheels

MODEL		Cap. lbs.	WHEEL SIZE		Approx Deck Height
Steel Deck	Wood Deck		Swivel	Rigid	
302RR	303RR	1,000	8 x 2	8 x 2	13"
304RR	305RR	2,000	8 x 2	8 x 2 ^{1/2}	14"
306RR	307RR	3,000	8 x 2 ^{1/2}	10 x 3	14"
308RR	309RR	4,000	8 x 2 ^{1/2}	10 x 4	15
310RR	311RR	5,000	10 x 3	12 x 4	15
312RR	313RR	6,000	10 x 4	12 x 4	15

Polyurethane Wheels

MODEL		Cap. lbs.	WHEEL SIZE		Approx Deck Height
Steel Deck	Wood Deck		Swivel	Rigid	
302UR	303UR	1,000	8 x 2	8 x 2	13"
304UR	305UR	2,000	8 x 2	8 x 2	14
306UR	307UR	3,000	8 x 2	8 x 2	14
308UR	309UR	4,000	8 x 2	8 x 2 ^{1/2}	15
310UR	311UR	5,000	8 x 2	8 x 2 ^{1/2}	15
312UR	313UR	6,000	8 x 2	8 x 3	15

Steel Wheels

MODEL		Cap. lbs.	WHEEL SIZE		Approx Deck Height
Steel Deck	Wood Deck		Swivel	Rigid	
302MR	303MR	1,000	8 x 2	8 x 2	13"
304MR	305MR	2,000	8 x 2	8 x 2	14
306MR	307MR	3,000	8 x 2	8 x 2	14
308MR	309MR	4,000	8 x 2	8 x 2 ^{1/2}	15
310MR	311MR	5,000	8 x 2	8 x 3	15
312MR	313MR	6,000	8 x 2	8 x 3	15

STANDARD OPTIONS AVAILABLE
 'T' RACK (SHOWN BELOW)
 COUPLERS - PG 8



How to Order: 307RR-2T-C7-C17 36x60

- DECK SIZE (36X60)
- REAR COUPLER OPTION
- FRONT COUPLER OPTION
- 'T' RACK OPTION
- WHEEL TYPE
- MODEL NUMBER

Fifth Wheel Steer Trailers

Light Duty
1,500 to 5,500 lbs.



353NF-C7

Standard deck sizes up to 48x96. Other sizes and capacities available upon request.

- Formed steel channel frame
- Steel or hardwood deck
- Max. Speed 5mph

- Safety type 'T' handle that will not drop to floor
- Wheels equipped with roller brg. & grease zerks
- Grease plate type fifth wheel



352RR

STANDARD OPTIONS AVAILABLE
RACKS - PG 11
COUPLERS - PG 8



Mold-On Rubber Wheels					Full Pneumatic Wheels				
MODEL		Cap. lbs.	Wheel Size	Approx. Deck Height*	MODEL		Cap. lbs.	Wheel Size	Approx. Deck Height*
Steel Deck	Wood Deck				Steel Deck	Wood Deck			
350RR	351RR	1,500	6 x 2	9"	350NF	351NF	1,500	10 x 3 1/2 4ply	13"
352RR	353RR	2,500	8 x 2 1/2	11"	352NF	353NF	2,500	16 x 5 4ply	19"
354RR	355RR	3,500	10 x 3	13"	354NF	355NF	3,500	16 x 5 4ply	19"
356RR	357RR	4,500	12 x 3	15"	356NF	357NF	4,500	16 x 5 6ply	19"
358RR	359RR	5,500	12 x 3 1/2	15"	358NF	359NF	5,500	12 x 3 1/2 6ply	15"
Polyurethane Wheels					Plastic Wheels				
MODEL		Cap. lbs.	Wheel Size	Steel Deck Height*	MODEL		Cap. lbs.	Wheel Size	Steel Deck Height*
Steel Deck	Wood Deck				Steel Deck	Wood Deck			
350UR	351UR	1,500	6 x 2	9"	350PR	351PR	1,500	6 x 2	9"
352UR	353UR	2,500	8 x 2	11"	352PR	353PR	2,500	8 x 2	11"
354UR	355UR	3,500	8 x 2	11"	354PR	355PR	3,500	8 x 2	11"
356UR	357UR	4,500	10 x 2 1/2	13"	356PR	357PR	4,500	10 x 2 1/2	13"
358UR	359UR	5,500	10 x 2 1/2	13"	358PR	359PR	5,500	10 x 2 1/2	13"

*Add 7/8" for Wood Deck



Standard Paint Color is Blue, other colors available.

How to Order: 350NF-C7-C17 30x48

- DECK SIZE (30X48)
- REAR COUPLER OPTION
- FRONT COUPLER OPTION
- 'T' RACK OPTION
- WHEEL TYPE
- MODEL NUMBER

Fifth Wheel Steer Trailers

Light Medium Duty
5,500 to 8,000 lbs.

- Heavy duty channel frame.
- Wheels w/roller brg.
- Grease plate type fifth wheel.

- Steel or Kiln dried select hard wood deck
- Ring Grip Tongue; 4" i.d.
- Max. Speed 5mph



361RR

Standard deck sizes up to 48x120. Other sizes and capacities available upon request.

How to Order: 360RR-C18 48x96

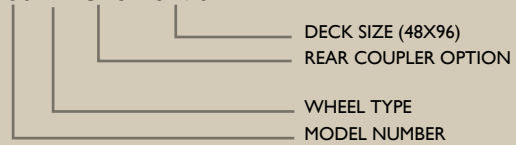

Mold-On Rubber Wheels

MODEL		Cap. lbs.	Wheel Size	Approx. Deck Height
Steel Deck	Wood Deck			
360RR	361RR	5,500	12 X 3 ^{1/2}	16"
362RR	363RR	6,500	12 X 4	16"
364RR	365RR	8,000	12 X 5	16"

Mold-On Rubber Wheels

MODEL		Cap. lbs.	Wheel Size	Approx. Deck Height
Steel Deck	Wood Deck			
366RR	367RR	10,000	16 X 5	22"
368RR	369RR	12,000	20 X 5	26"

Polyurethane Wheels

MODEL		Cap. lbs.	Wheel Size	Approx. Deck Height
Steel Deck	Wood Deck			
366UR	367UR	10,000	12 X 3 ^{1/2}	16"
368UR	369UR	12,000	14 X 4	18"

Medium Duty
10,000 to 12,000 lbs.



366RR

Standard deck sizes up to 48x120. Other sizes and capacities available upon request.

STANDARD OPTIONS AVAILABLE

TRAILER OPTIONS - PG 7

COUPLERS - PG 8



Standard Paint Color is Blue, other colors available.

Fifth Wheel Steer Trailers

Light Medium to Medium Duty
5,000 to 7,000 lbs.

- Heavy duty channel frame.
- Wheels w/Timken Tapered brg.
- Grease plate type fifth wheel.
- Ring Grip Tongue; 4" i.d.

- Steel or Kiln dried select hard wood deck
- Max. Speed 5mph

How to Order: 370NF-C18 4896



370NF

Standard deck sizes up to 48x120. Other sizes and capacities available upon request

Pneumatic Wheels				
MODEL		Cap. lbs.	Wheel Size	Approx. Deck Height
Steel Deck	Wood Deck			
370NF	371NF	5,000	18 x 6 6ply	24"
372NF	373NF	6,000	18 x 6 6ply	24"
374NF	375NF	7,000	18 x 6 8ply	24"
376NF	377NF	8,000	21 x 7 10ply	27"

DECK SIZE (48X96)
REAR COUPLER OPTION
WHEEL TYPE
MODEL NUMBER

STANDARD OPTIONS AVAILABLE
TRAILER OPTIONS - PG 7
COUPLERS - PG 8

- Heavy Channel frame.
- Four way floor plate deck. (standard) other options avail.
- Ring Grip tongue; 4" i.d.
- Max. Speed 5mph

- Heavy Duty grease plate type fifth wheel.
- NOW with hydraulic surge or electric over hydraulic disk brakes.



Heavy Duty
20,000 to 40,000 lbs.

380RO

Standard deck sizes up to 60x144.
Other sizes and capacities up to 200,000 lbs. available upon request.

Capacity: 20,000				Capacity: 40,000			
Model	Wheel Size	Wheel Type	Approx. Deck Height	Model	Wheel Size	Wheel Type	Approx. Deck Height
380RO	15 x 8 x 11 1/4"	Press on Rubber*	20"	382RO	15 x 8 x 11 1/4"	Press on Rubber*	24"
380UO	15 x 8 x 11 1/4"	Press on Poly	20"	382UO	15 x 8 x 11 1/4"	Press on Poly	24"

How to Order: 380RO-C18 60x144

*(4) 70 Durometer

*(8) 70 Durometer (Minimum Truck Width 48")

DECK SIZE (60X144)
REAR COUPLER OPTION
WHEEL TYPE
MODEL NUMBER

Press-On Wheels



- Lube Fitting
- Tapered Roller brg.
- Cast Iron Center Wheel
- Steel Rim with Vulcanized Tread
- Thick, Replaceable Rubber or Poly Tread.

- Sealed Bearings
- 8^{3/8}" Hub Length
- Approx. Weight 155 lbs.
- Smooth Tread
- Max. Speed 5mph

70 Dur. Rubber				Polyurethane			
Model	Wheel Size	Axle Size	Capacity	Model	Wheel Size	Axle Size	Capacity
ROV15-3-1 ^{3/4} -8 ^{3/8}	15 x 8 x 1 1/4"	1 3/4"	5,000	UOV15-3-1 ^{3/4} -8 ^{3/8}	15 x 8 x 1 1/4"	1 3/4"	10,000
ROV15-3-2-8 ^{3/8}	15 x 8 x 1 1/4"	2"	5,000	UOV15-3-2-8 ^{3/8}	15 x 8 x 1 1/4"	2"	10,000

Fifth Wheel Trailer Options

- Ball Brg. Fifth Wheel Plates
- Rear Hitch
- Smooth Steel Deck
- Open Frame Deck
- Custom Deck Sizes
- Double End Steer
(Add the prefix **D** to Model Numbers)
Extra Fifth Wheel Plate Assembly and Hounds at the rear end (w/locking pin and removable tongue) for front and rear towing.
- Four Wheel Steer
(Add the prefix **F** to Model Numbers)
Extra Fifth Wheel Plate Assembly at the rear end and adjustable tie bar between the front and rear end assembly providing excellent tracking and a shorter turning radius than the standard wagon.

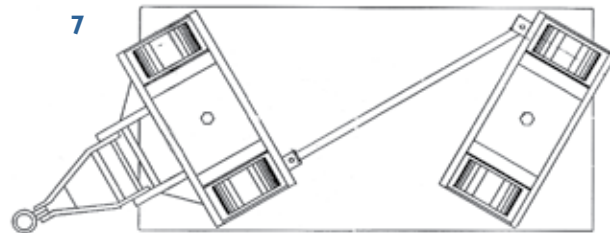
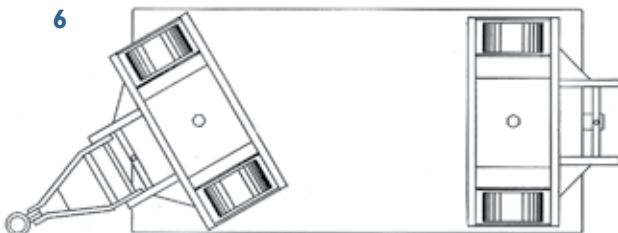

Couplers

- C1** 20,000 lbs. max. truck capacity
Counterbalanced bail
- C2** 8,000 lbs. max. truck capacity
Counterbalanced bail
- C3** 6,000 lbs. max. truck capacity
Spring loaded bail
- C4** 2,500 lbs. max. truck capacity
Counterbalanced bail
- C5** 2,500 lbs. max. truck capacity
Spring loaded bail
- C6** 8,000 lbs. max. truck capacity
Hook Coupler
- C7** 3,000 lbs. max. truck capacity
Hook Coupler
- C8** 10,000 lbs. max. truck capacity
Ring Coupler
- C9** 3,000 lbs. max. truck capacity
Ring Coupler
- C11** 20,000 lbs. max. truck capacity
Jaw Coupler
- C12** 8,000 lbs. max. truck capacity
Jaw Coupler
- C14** 2,500 lbs. max. truck capacity
Jaw Coupler
- C16** 8,000 lbs. max. truck capacity
Towing Eye
- C17** 3,000 lbs. max. truck capacity
Towing Eye
- C18** 10,000 lbs. max. truck capacity
Pin & Clevis
- C19** 20,000 lbs. max. truck capacity
Pintle Hitch
- C20** 40,000 lbs. max. truck capacity
Jeep Pintle Hitch
- C21** 10,000 lbs. max. truck capacity
Counterbalanced bail
- C22** 10,000 lbs. max. truck capacity
Jaw Coupler



C1



C2



C3



C4



C5



C6



C7



C8



C9



C11



C12



C14



C16



C17



C18



C19



C20



C21



C22



Standard Paint Color is Blue, other colors available.

All Wood Decks

Kiln-dried select hardwood deck



235RR-A



T-235RR-4E



6T-237RR-B

Standard deck sizes up to 42x72. Other sizes and capacities available upon request.

Mold-On Rubber Wheels

Model	Wheel Size	Cap. lbs.	Approx. Deck Height
235RR	5 x 2	1,300	9"
237RR	6 x 2	1,800	10"
239RR	8 x 2	2,200	12"

Plastic Wheels

Model	Wheel Size	Cap. lbs.	Approx. Deck Height
235PR	5 x 2	2,200	9"
237PR	6 x 2	2,200	10"
239PR	8 x 2	2,200	12"

Polyurethane Wheels

Model	Wheel Size	Cap. lbs.	Approx. Deck Height
235UR	5 x 2	2,200	9"
237UR	6 x 2	2,200	10"
239UR	8 x 2	2,200	12"

Semi-Steel Wheels

Model	Wheel Size	Cap. lbs.	Approx. Deck Height
235MR	5 x 2	2,200	9"
237MR	6 x 2	2,200	10"
239MR	8 x 2	2,200	12"

How to Order: 235RR-B 30x60

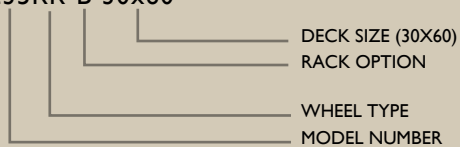

For 4 Wheel Tilt add prefix T.
 For 6 Wheel Tilt add prefix 6T.
 See PG 11 for description and wheel placement.

STANDARD OPTIONS AVAILABLE
 ACCESSORIES & RACK OPTIONS - PG 11



Standard Paint Color is Blue, other colors available.



Wood or Steel Deck - Steel Frame



220RR-B



216RR-B

Standard deck sizes up to 48x96. Other sizes and capacities available upon request.

- Steel Frame
- Kiln dried Select Hardwood or Steel Deck
- Medium Heavy duty, plate type casters welded to frame.
- Two pipe pockets on each end.
- Weld-on Casters
- Optional bolt-on casters

Mold-On Rubber Wheels

MODEL		Cap. lbs.	WHEEL SIZE		Approx. Steel Deck Height*
Steel	Wood		Swivel	Rigid	
210SH	211SH	750	4 x 1 ^{1/4}	4 x 1 ^{1/4}	7"
212RR	213RR	1,000	5 x 2	5 x 2	8"
214RR	215RR	1,500	6 x 2	6 x 2	9"
216RR	217RR	2,000	8 x 2	8 x 2	11"
218RR	219RR	2,500	8 x 2	8 x 2 ^{1/2}	11"
220RR	221RR	3,000	8 x 2 ^{1/2}	10 x 2 ^{1/2}	12"
222RR	223RR	3,500	8 x 2 ^{1/2}	10 x 3	12"
224RR	225RR	4,000	10 x 2 ^{1/2}	12 x 3	14"

Polyurethane Wheels

MODEL		Cap. lbs.	WHEEL SIZE		Approx. Steel Deck Height*
Steel	Wood		Swivel	Rigid	
210UR	211UR	750	4 x 1 ^{1/4}	4 x 1 ^{1/4}	7"
212UR	213UR	1,000	5 x 2	5 x 2	8"
214UR	215UR	1,500	5 x 2	5 x 2	8"
216UR	217UR	2,000	5 x 2	5 x 2	8"
218UR	219UR	2,500	6 x 2	6 x 2	9"
220UR	221UR	3,000	6 x 2	8 x 2	11"
222UR	223UR	3,500	6 x 2	8 x 2	11"
224UR	225UR	4,000	6 x 2	8 x 2	11"

Plastic Wheels

MODEL		Cap. lbs.	WHEEL SIZE		Approx. Steel Deck Height*
Steel	Wood		Swivel	Rigid	
210PR	211PR	750	4 x 1 ^{1/4}	4 x 1 ^{1/4}	7"
212PR	213PR	1,000	5 x 2	5 x 2	8"
214PR	215PR	1,500	5 x 2	5 x 2	8"
216PR	217PR	2,000	5 x 2	5 x 2	8"
218PR	219PR	2,500	6 x 2	6 x 2	9"
220PR	221PR	3,000	6 x 2	8 x 2	11"
222PR	223PR	3,500	6 x 2	8 x 2	11"
224PR	225PR	4,000	6 x 2	8 x 2	11"

Steel Wheels

MODEL		Cap. lbs.	WHEEL SIZE		Approx. Steel Deck Height*
Steel	Wood		Swivel	Rigid	
210MR	211MR	750	4 x 1 ^{1/4}	4 x 1 ^{1/4}	7"
212MR	213MR	1,000	5 x 2	5 x 2	8"
214MR	215MR	1,500	5 x 2	5 x 2	8"
216MR	217MR	2,000	5 x 2	5 x 2	8"
218MR	219MR	2,500	6 x 2	6 x 2	9"
220MR	221MR	3,000	6 x 2	8 x 2	11"
222MR	223MR	3,500	6 x 2	8 x 2	11"
224MR	225MR	4,000	6 x 2	8 x 2	11"

How to Order: 220RR-B 48x96



For 4 Wheel Tilt add prefix T.
 For 6 Wheel Tilt add prefix 6T.
 See PG 11 for description, wheel placement, accessories and rack options.

*for wood decks add approx. 3/4"

Nestable Trucks

- Wood or Steel Deck
- Steel Frame
- Spring-loaded deck for nesting
- Medium Heavy Duty Plate Type Casters welded to frame.
- Opt. Wire Basket



Standard deck sizes up to 30x60. Other sizes and capacities available upon request.

Mold-On Rubber Wheels				Plastic Wheels			
MODEL		Cap. lbs.	Wheel Size	MODEL		Cap. lbs.	Wheel Size
Steel Deck	Plywood Deck			Steel Deck	Plywood Deck		
226RR	227RR	1,500	8 x 2	226PR	227PR	1,500	8 x 2

How to Order: 226RR 24x48

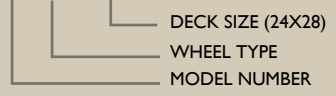

Truck Accessories

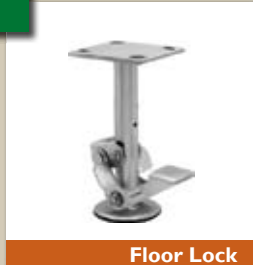

Rack Options



A & B Racks also available in Stainless Steel; E Rack: Stakes made of steel; F Rack: Stakes made of wood.

Wheel Placements for Platform Trucks

FOUR WHEEL TILT TYPE
 For Tilt Type Construction add the prefix **T** to Model Numbers Above.
 All four wheels rest on floor for maximum capacity. Tilt type trucks have the same features as non tilt plus they will turn within their own diagonal length.
 Angle Iron Frame Truck has 1/2" Tilt

SIX WHEEL TILT TYPE
 For Tilt Type Construction add the prefix **6T** to Model Numbers Above.
 All six wheels rest on floor for maximum capacity. Tilt type trucks will turn within their own diagonal length.
 Angle Iron Frame Truck has 1/2" Tilt



Wood or Steel Deck - Angle Frame



259RR-A

Standard deck sizes up to 48x96. Other sizes and capacities available upon request.

- Angle Iron Frame
- Steel or Kiln-dried select hardwood deck
- Two Pipe pockets on each end
- Bolted-on casters



258RR-B

STANDARD OPTIONS AVAILABLE ACCESSORIES - PG 11

Mold-On Rubber Wheels

MODEL		Cap. lbs.	WHEEL SIZE		Approx. Deck Height
Steel Deck	Wood Deck		Load Wheel	Swivel Caster	
256RR	257RR	1,400	8 x 2	4 x 2	10"
258RR	259RR	2,100	10 x 2 ^{1/2}	5 x 2	12"
260RR	261RR	2,400	12 x 2 ^{1/2}	6 x 2	14"
262RR	263RR	2,600	12 x 2 ^{1/2}	6 x 2	14"
264RR	265RR	3,000	14 x 2 ^{1/2}	8 x 2	16"
266RR	267RR	3,100	12 x 3	6 x 2	14"
268RR	269RR	3,400	16 x 3	8 x 2	18"
270RR	271RR	3,500	14 x 3	8 x 2	16"
272RR	273RR	3,600	18 x 2 ^{1/2}	8 x 2	20"
274RR	275RR	3,600	18 x 2 ^{1/2}	8 x 2 ^{1/2}	20"
276RR	277RR	4,200	16 x 3	8 x 2 ^{1/2}	18"
278RR	279RR	4,600	18 x 3	10 x 2 ^{1/2}	20"

Plastic Wheels

MODEL		Cap. lbs.	WHEEL SIZE		Approx. Deck Height
Steel Deck	Wood Deck		Load Wheel	Swivel Caster	
256PR	257PR	1,500	5 x 2	4 x 2	10"
258PR	259PR	2,000	6 x 2	5 x 2	12"
262PR	263PR	2,500	8 x 2	5 x 2	13"
264PR	265PR	3,000	8 x 2	6 x 2	13"
270PR	271PR	3,500	8 x 2 ^{1/2}	6 x 2	13"
276PR	277PR	4,000	10 x 2 ^{1/2}	6 x 2	14"
278PR	279PR	4,500	10 x 2 ^{1/2}	8 x 2	15"

Polyurethane Wheels

MODEL		Cap. lbs.	WHEEL SIZE		Approx. Deck Height
Steel Deck	Wood Deck		Load Wheel	Swivel Caster	
256UR	257UR	1,500	5 x 2	4 x 2	10"
258UR	259UR	2,000	6 x 2	5 x 2	12"
262UR	263UR	2,500	8 x 2	5 x 2	13"
264UR	265UR	3,000	8 x 2	6 x 2	13"
270UR	271UR	3,500	8 x 2 ^{1/2}	6 x 2	13"
276UR	277UR	4,000	10 x 2 ^{1/2}	6 x 2	14"
278UR	279UR	4,500	10 x 2 ^{1/2}	8 x 2	15"

Steel Wheels

MODEL		Cap. lbs.	WHEEL SIZE		Approx. Deck Height
Steel Deck	Wood Deck		Load Wheel	Swivel Caster	
256MR	257MR	1,500	5 x 2	4 x 2	10"
258MR	259MR	2,000	6 x 2	5 x 2	12"
262MR	263MR	2,500	8 x 2	5 x 2	13"
264MR	265MR	3,000	8 x 2	6 x 2	13"
270MR	271MR	3,500	8 x 2 ^{1/2}	6 x 2	13"
276MR	277MR	4,000	10 x 2 ^{1/2}	6 x 2	14"
278MR	279MR	4,500	10 x 2 ^{1/2}	8 x 2	15"

How to Order: 259RR-A 48x96

DECK SIZE (48X96)

RACK OPTION

WHEEL TYPE

MODEL NUMBER

For 4 Wheel Tilt add prefix T (Capacities are reduced on the 4-wheel tilt angle iron frames).

For 6 Wheel Tilt add prefix 6T.

See PG 11 for description and wheel placement.

Wood or Steel Decks - Steel Frame

- Steel Frame
- Medium Heavy Duty Plate Type casters welded to frame.
- Choice of Socket or Pin Lift Coupling



M95RR



96RR

Standard deck sizes up to 48x96. Other sizes and capacities available upon request.

Mold-On Rubber Wheels					Steel Wheels				
MODEL		Cap. lbs.	Wheel Size	Approx. Steel Deck Height	MODEL		Cap. lbs.	Wheel Size	Approx. Steel Deck Height
Steel Deck	Wood Deck				Steel Deck	Wood Deck			
94RR	95RR	2,000	8 x 2	11"	94MR	95MR	2,000	8 x 2	11"
96RR	97RR	3,000	8 x 2 ^{1/2}	11"	96MR	97MR	3,000	8 x 2	11"

Polyurethane Wheels					Plastic Wheels				
MODEL		Cap. lbs.	Wheel Size	Approx. Steel Deck Height	MODEL		Cap. lbs.	Wheel Size	Approx. Steel Deck Height
Steel Deck	Wood Deck				Steel Deck	Wood Deck			
94UR	95UR	2,000	8 x 2	11"	94PR	95PR	2,000	8 x 2	11"
96UR	97UR	3,000	8 x 2	11"	96PR	97PR	3,000	8 x 2	11"

For Wood Decks add 3/4"

All Wood Deck & Frame



83RR

Mold-On Rubber Wheels				Steel Wheels			
Model	Cap. lbs.	Wheel Size	Approx. Deck Height	Model	Cap. lbs.	Wheel Size	Approx. Deck Height
83RR	2,200	8 x 2	12"	83MR	2,200	8 x 2	12"

Plastic Wheels				Polyurethane Wheels			
Model	Cap. lbs.	Wheel Size	Approx. Deck Height	Model	Cap. lbs.	Wheel Size	Approx. Deck Height
83PR	2,200	8 x 2	12"	83UR	2,200	8 x 2	12"

Standard deck sizes up to 42x72. Other sizes and capacities available upon request.

How to Order: M95RR 48x96
M83RR 48x96

For Pin Coupling IPO
Socket add prefix M to
Model Number.

DECK SIZE (48X96)
WHEEL TYPE
MODEL NUMBER (DELETE M WHEN FEMALE SOCKET IS REQUIRED)

Lift Units



F9I



9I

Mold-On Rubber Wheels				Steel Wheels			
MODEL		Wheel Size	Approx. Handle Length	MODEL		Wheel Size	Approx. Handle Length
Pin	Socket			Pin	Socket		
91RR	F91RR	8 x 2	6'	91MR	F91MR	8 x 2	6'

Polyurethane Wheels				Plastic Wheels			
MODEL		Wheel Size	Approx. Handle Length	MODEL		Wheel Size	Approx. Handle Length
Pin	Socket			Pin	Socket		
91UR	F91UR	8 x 2	6'	91PR	F91PR	8 x 2	6'

How to Order: F91RR

WHEEL TYPE
MODEL NUMBER (DELETE F WHEN PIN IS REQUIRED)

Miscellaneous Trucks



DOUBLE SIDED A-FRAME TRUCK

CAPACITY: 2,000 lbs.
WHEEL SIZE: 8X2
WHEEL TYPES: Mold-on Rubber, Plastic, Polyurethane, Steel
Standard deck sizes up to 42x72



3-SIDED EXPANDED METAL TRUCK

CAPACITY: 2,000 lbs. - 60" overall height
(Optional shelf shown) WHEEL SIZE: 8X2
WHEEL TYPES: Mold-on Rubber, Plastic, Polyurethane, Steel
Standard deck sizes up to 48x96



BOX TRUCK

CAPACITY: 2,000 lbs. - 24" deep
WHEEL TYPES & SIZES:
Mold-On Rubber (8x2), Plastic (5x2)
Polyurethane (5x2)
Standard deck sizes up to 42x72



3 LEVEL SHELF TRUCK

CAPACITY: 800 lbs. - 34" overall height
WHEEL TYPE & SIZE:
Hard Rubber Wheels (4x1 1/4")
Standard deck sizes - 24x36, 24x48



LADDER TRUCK

CAPACITY: 1,200 lbs.
WHEEL TYPE & SIZE:
Mold-On Rubber (5x2)
Standard deck size - 24x42



BUILDERS MATERIAL CART

CAPACITY: 900 lbs.
WHEEL TYPE & SIZE:
Mold-On Rubber (5x2)
Standard deck size - 30x30



CRADLE TRUCK

60" trucks have 3 cradles, 96" & 120" have 4 cradles

Plastic Wheels

Model	Cap. lbs.	Width	Length	Wheel Size
401PR	4,000	28	60, 96	10, 8
402PR	10,000	28	60, 96, 120	12, 8

Steel Wheels

Model	Cap. lbs.	Width	Length	Wheel Size
401MR	4,000	28	60, 96	10, 8
402MR	10,000	28	60, 96, 120	12, 8

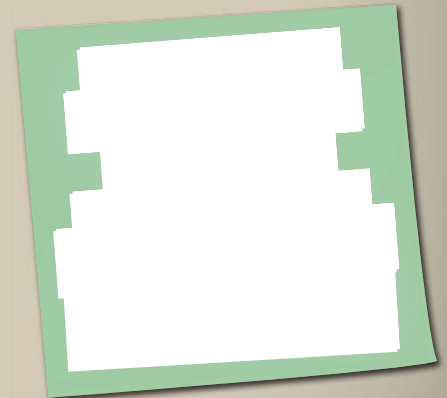

Heavy Duty Industrial Hand Trucks



40-10NF



41-10NS



42-10NS



43-10NF



44-10NS



4610NS



47-10NS



30-08RR



30C-08RR



45-10RT



55-10RT



SS42-10NS

Model	Frame Width	Overall Height	Nose Length	WHEEL TYPE & SIZE			Weight (lbs)
				Semi Pneumatic	Full Pneumatic	Mold-On Rubber	
40-10NS 40-10NF 40-10RR	14"	46"	7 1/2"	10x2 ^{3/4}	--	--	35
41-10NS 41-10NF 41-10RR	14"	46"	7 1/2"	10x2 ^{3/4}	410/350-4	--	35
42-10NS 42-10NF 41-10RR	14"	46"	7 1/2"	10x2 ^{3/4}	--	10x2	35
43-10NS 43-10NF 43-10RR	14"	53"	7 1/2"	10x2 ^{3/4}	410/350-4	--	39
44-10NS 44-10NF 44-10RR	14"	52"	7 1/2"	10x2 ^{3/4}	410/350-4	--	38
46-10NS 46-10NF 46-10RR	14"	53"	7 1/2"	10x2 ^{3/4}	410/350-4	--	39
47-10NS 47-10NF 47-10RR	14"	46"	7 1/2"	10x2 ^{3/4}	410/350-4	--	35
45-10RT	23" ¹	60" ²	7 1/2"	--	--	10x2 ^{1/2}	50
55-10RT	23" ¹	60" ²	7 1/2"	--	--	5x1 ^{1/2} AND 10x2 ^{1/2}	65
30-08RR 30C-08RR*	20"	46"	5 1/2"	--	--	8x2	75
30-08PR 30C-08PR	20"	46"	5 1/2"	--	--	PLASTIC 8x2	75
SS42-10NS (Stainless Steel)	14"	46"	7 1/2"	10x2 ^{3/4}	--	--	35



Wheel Types

- A - Full-Pneumatic**
(410/350-4)
- B - Semi-Pneumatic**
(10 x 2.75)
- C - Mold-On Rubber**
(10 x 2)
- D - Mold-On Rubber**
(8 x 2)

Full & Semi Pneumatic Wheels have sealed ball bearings.
Mold-On Wheels have roller bearings.

* Curved cross -straps

¹ Overall width

² Handle length

Barrel Dollies



70-SH30 - 19" Dia.
70-SH55 - 24" Dia.



71-SH30 - 19" Dia.
71-SH55 - 24" Dia.



SS70-SH30 - 19" Dia.
SS70-SH55 - 24" Dia.



SS71-SH30 - 19" Dia.
SS71-SH55 - 24" Dia.

- All steel welded & swivel casters (mild or stainless steel)
- (4) 3" Rubber Wheels
- Holds 30 or 55 gallon drums
- 800 lbs. Capacity

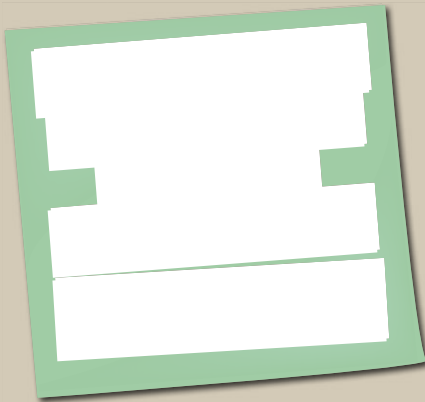

Industrial Wood Dollies



63SH3



64SH4



65SH5



66SH3



C64SH4



R65SH

- Kiln-Dried Select Hardwood
- Standard casters available (4)3", (4)4" (4)5" Hard Rubber Swivels - all tread widths 1 1/4"
- 900 lbs. Capacity



Dolly Accessories

How to Order: 63SH3 18x36

Add **C** as a prefix for Carpet Option on 64 & 65 series. Add **R** as a prefix for Rubber-end caps option on 64 & 65 series 18" wide only.

W x L (18x36)
WHEEL SIZE

WHEEL TYPE

MODEL NUMBER

Steel Dollies



Model	Wheel Type	Sizes	Height	RUBBER WHEELS		PLASTIC WHEELS		METAL WHEELS		POLYURETHANE WHEELS	
				Size*	Capacity	Size*	Capacity	Size*	Capacity lbs.	Size*	Capacity
72SH	Rubber Solid Hard	15x17 19x30 19x45	5 ¹³ / ₁₆ "	3x1 ¹ / ₄ "	800	N/A	N/A	N/A	N/A	N/A	N/A
73RR 73PR 73MR 73UR	Rubber Plastic Metal Polyurethane	26x36 26x48 32x48 32x48 32x60	Under-Clearance 7 ³ / ₈ " OR 9 ¹ / ₄ "	4x2 OR 6X2	1,000 2,000	4x2 6x2	2,000 2,000	4x2 6x2	2,000 2,000	4x2 6x2	2,000 2,000
75RR 75PR 75MR 75UR	Rubber Plastic Metal Polyurethane	18x36 18x42 18x48	10 ¹ / ₂ "	5x2 AND 8X2	1,900	5x2 AND 8X2	3,000	5x2 AND 8X2	3,000	5x2 AND 8X2	3,000
76RR 76PR 76MR 76UR	Rubber Plastic Metal Polyurethane	24x48 30x60	9 ³ / ₁₆ "	8x2 ¹ / ₂ "	2,800	8x2 ¹ / ₂ "	6,000	8x2 ¹ / ₂ "	6,000	8x2 ¹ / ₂ "	6,000
77RR 77PR 77MR 77UR	Rubber Plastic Metal Polyurethane	18x24 24x36 30x42	8 ³ / ₁₆ "	5x2	1,000	5x2	3,000	5x2	3,000	5x2	3,000
78SH 78PR 78MR	Hard Rubber Plastic Metal	18x24 18x30 24x30	4 ³ / ₁₆ " 6" 6"	3x1 ¹ / ₄ "	800	4x2	2,000	4x2	2,000	N/A	N/A
80MR	Metal	30x48 36x60	9 ³ / ₄ "	N/A	N/A	N/A	N/A	8x2 ¹ / ₄ "	8,000	N/A	N/A

How to Order: 78PR 24x30

*Other Sizes Available

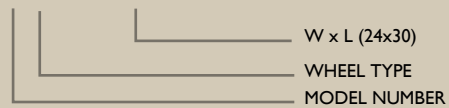

Pry Trucks



15-05MR

16-05RR

13-06MR

Specifications

Model	Capacity (steel only)	NOSE		WHEELS		Handle Length
		Width	Length	Steel	Rubber or Plastic	
HARDWOOD HANDLE						
No. 16-05	2,000	6"	3"	5x2	5x2	7'
No. 15-05	2,000	6"	3"	5x2	5x2	6'
No. 14-05	2,000	6"	3"	5x2	5x2	5'
STEEL HANDLE						
No. 13-06	2,400	3 ¹ / ₄ "	7 ³ / ₄ "	6x2	N/A	6'

Two Steel Wheels, Four Rubber or Plastic

- Use in Pairs or Singly
 - Great for loads too bulky for standard hand trucks
 - One of the handiest trucks made

Pry Trucks used in pairs enable two men to tackle a mountain of freight too big or too bulky to handle manually with anything else. Powerful leverage enables users to easily raise loads as high as nine inches above the floor--high enough for rollers or dollies to be placed beneath them. Although often used in pairs, an amazing amount of work can be done by one man with a Pry Truck. They handle loads too bulky for ordinary two wheel trucks. Heavy, bulky crates and machinery can be quickly and easily shifted, stored, loaded or unloaded in and out of trucks, freight cars and other tight spaces.

Pry Load Up on the Crowbar Nose Roll it Away on the Rugged Wheels.

Parts Bin, Coil Rack & Modular Storage Rack



Stackable!

PARTS BIN 820-3024

4,000 lb. Capacity
Stackable up to Six High
Dividers & Cardholders Available

Model	Length* (Inches)	Width (Inches)	Weight (Pounds)
820-3024	30	24	110
820-3030	30	30	124
820-3036	30	36	138
820-3048	30	48	166

*Add 8 1/2 inches for front slope. Overall height 25 inches.



Stackable!

COIL RACK 826-2-2060

2,000 & 4,000 lb. Capacity
Holds Coils with 24 - 48 Inch Diameter

Model	Coil Diameter	Width (Inches)	Height (Inches)	Weight (lbs)
2,000 Pound Capacity				
826-2-2060	24 - 28	20	33	73
826-2-2260	29 - 33	22	37 1/2	78
826-2-2460	34 - 38	24	42 1/2	83
826-2-2660	39 - 43	26	47 1/2	88
826-2-2860	44 - 48	28	53	94

Model	Coil Diameter	Width (Inches)	Height (Inches)	Weight (lbs)
4,000 Pound Capacity				
826-4-2060	24 - 28	20	33	109
826-4-2260	29 - 33	22	37 1/2	116
826-4-2460	34 - 38	24	42 1/2	125
826-4-2660	39 - 43	26	47 1/2	132
826-4-2860	44 - 48	28	53	140

All units 60 inches long



Stackable!

MODULAR STORAGE RACK 824-1

2,000, 4,000, 6,000 & 8,000 Capacity
Up to Five Bay Lengths Available

Model	DIMENSIONS (Inches)			Weight (lbs.)
	Width	Length	Height	
2,000 Pound Capacity				
828-1	12	16	13 1/2	19
4,000 Pound Capacity				
830-1	14	19	17	25
6,000 Pound Capacity				
832-1	15	22	20 1/2	34
8,000 Pound Capacity				
834-1	16	26	23 1/2	40

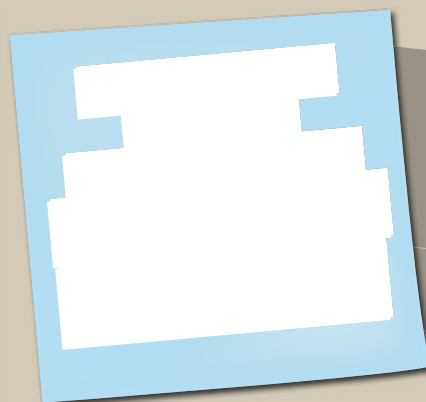

2,000 & 4,000 lb. Capacity

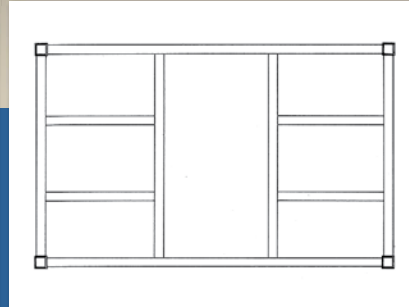
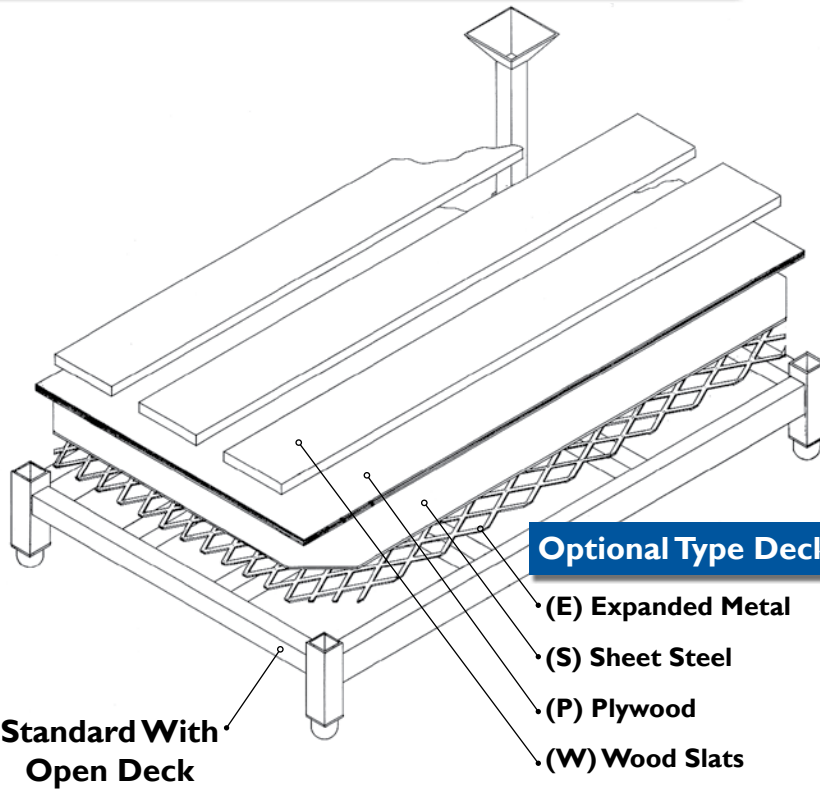

Base Frame Type 808

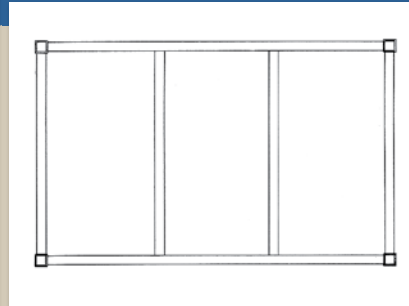

Base Frame Type 806

Standard 2,000 & 4,000 lb. capacity rack sizes are available up to 48x60. Standard under-clearance 4^{1/2}" on lengthwise members. Other sizes and capacities available upon request.



808-2-3648

How to Order: 808-2-4242-9-S

- TYPE OF DECK - STEEL DECK (OMIT WHEN OPEN FRAME REQ'D)
- POCKET DEPTH - 9" (OMIT WHEN 6" POCKET REQ'D)
- LENGTH OF RACK - 42"
- WIDTH OF RACK - 42"
- 2000 LB CAPACITY
- 4-WAY ENTRY (2-WAY ENTRY 806)

BASE DECK OPTIONS

Pocket Depth

- 6 For 6" deep pockets with 39" (standard)
- 9 For 9" deep pockets with 40" to 48"
- 12 For 12" deep pockets with 49" to 72"
- 15 For 15" deep pockets with 73" to 90"

Type of Deck

- W Wood Slat Deck
- P Plywood Deck
- S Steel Deck
- X Expanded Metal Deck

Channel Collars

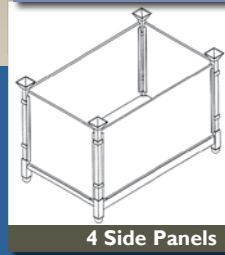
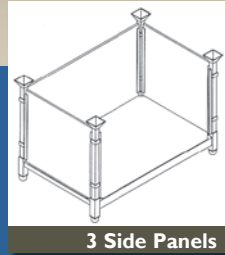
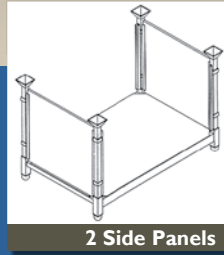
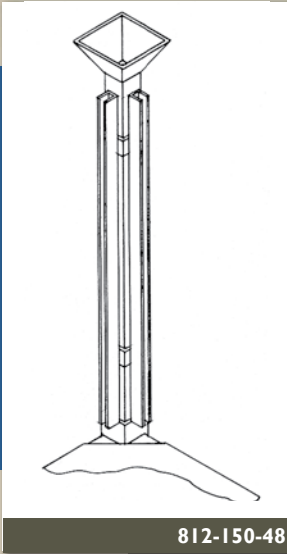

- Convert Open sided stack racks into bins
 - Add your own panels of 3/4" plywood, wood or steel OR let us supply.

- 2,000 or 4,000 lb capacities.
 - 4 channel collars per set

How to Order: 812-150-48

POST HEIGHT ABOVE OPEN FRAME
 150 - 2,000 LB. CAPACITY
 217 - 4,000 LB. CAPACITY
 CHANNEL COLLAR OPTION

Side/End Frames

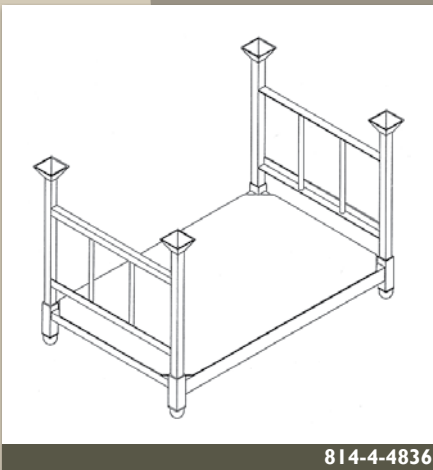

- Removable side frames give you flexibility in handling materials
 - 2 side/end frames per set
 - See pg 18 for pocket depth requirements for specified side/end frame heights

How to Order:

814-2-4836 "B" DIMENSION (NOMINAL HEIGHT)
 "A" DIMENSION (NOMINAL LENGTH)
 2 - 2,000 LB. CAPACITY
 4 - 4,000 LB. CAPACITY
 SIDE/END FRAME OPTION

Accessories for Rack



- Corner Posts
 - 2,000 or 4,000 lb cap.
 - Sold in sets of 4
 - See pg 18 for pocket depth requirements for specified post lengths

How to Order:

810-2-30 HEIGHT ABOVE OPEN FRAME TO BOTTOM OF TARGET
 2 - 2,000 LB. CAPACITY
 4 - 4,000 LB. CAPACITY
 POST OPTION

Bulk Liquid Container

- A** Standard 55 Gallon Drum Lid Opening
- B** Stacking Band
- C** Stacking Pad
- D** 2" Top Fill (Plugged)
- E** Heavy Gauge Sheet Steel
- F** Three Way Fork Entry
- G** Bottom Sump with 2" outlet
- H** Channel Valve Guard
- I** Leg Reinforcing Pad
- J** Pipe Legs



X336-42SS-TI-VS-LS(I)-Z-Z-Z

- Choice of Valves (Carbon, Stainless, Bronze)
- Available in Mild or Stainless Steel
- Reduce product loss
- Reduce labor cost

- Utilize floor space
- Stackable
- Store indoors or outside
- 178 to 644 gallon capacity

Specification 42 x 42 Square Tank

Model Number		Capacity (gallon)	Approx. Overall Ht.	Width (Approx.)	Length (Approx.)	SS Weight (Approx.)	MS Weight (Approx.)
Stainless Steel	Mild Steel						
178-42SS	178-42MS	178	32	42	42	270	285
200-42SS	200-42MS	200	35	42	42	285	300
246-42SS	246-42MS	246	41	42	42	316	330
291-42SS	291-42MS	291	47	42	42	346	360
336-42SS	336-42MS	336	53	42	42	377	390
382-42SS	382-42MS	382	59	42	42	408	506
472-42SS	472-42MS	472	71	42	42	585	754
563-42SS	563-42MS	563	83	42	42	664	858

Specification 42 x 48 Rectangular Tank

Model Number		Capacity (gallon)	Approx. Overall Ht.	Width (Approx.)	Length (Approx.)	SS Weight (Approx.)	MS Weight (Approx.)
Stainless Steel	Mild Steel						
203-48SS	203-48MS	203	32	42	48	293	310
229-48SS	229-48MS	229	35	42	48	310	326
281-48SS	281-48MS	281	41	42	48	343	359
333-48SS	333-48MS	333	47	42	48	376	392
385-48SS	385-48MS	385	53	42	48	408	504
437-48SS	437-48MS	437	59	42	48	441	546
540-48SS	540-48MS	540	71	42	48	638	819
644-48SS	644-48MS	644	83	42	48	722	931

- Bottom discharge is on the 42" end on 48" long tanks
- All tanks standard with 22 1/2" center top opening and 2" top fill (plugged)
- All tanks standard with 2" nipple bottom discharge
- Underclearance 6 1/2"
- Other capacity and sizes available
- All tanks are standard with 1" radius corners (2" available)
- All mild steel tanks are standard with natural finish, NO PAINT. Paint available.
- All stainless steel tanks are standard with 304 2B finish stainless except legs and valve guards that are mild steel and coated with a special aluminum paint. You must specify if an all stainless steel tank is required. Other stainless types and finishes available.

Liqui-Tainer Options & Accessories

Standard Drum Lids

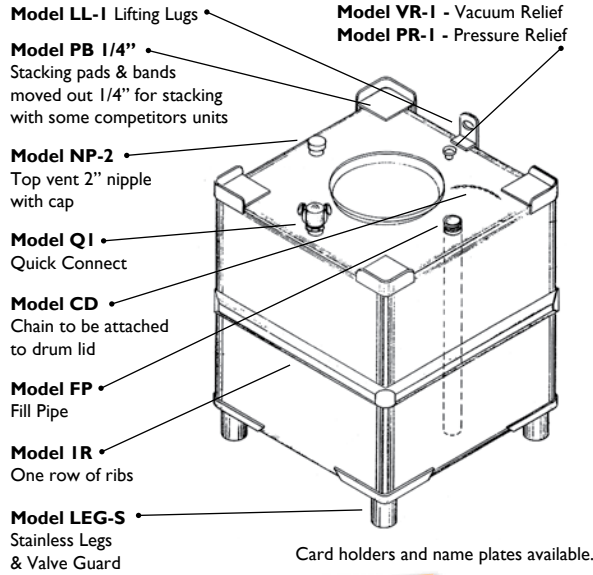

How to Order
by Number see
PG 24

- MODEL LS-1**
Stainless lid with plated bolted ring
- MODEL LM-1**
Mild steel unpainted lid with plated bolted ring
- MODEL LS-2**
Stainless lid with lever locking ring
- MODEL LM-2**
Mild steel unpainted lid with lever locking ring

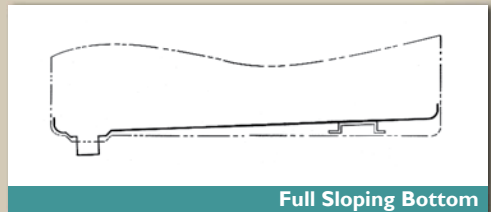

•Model DSS Stainless* •Model DSM Mild Steel*

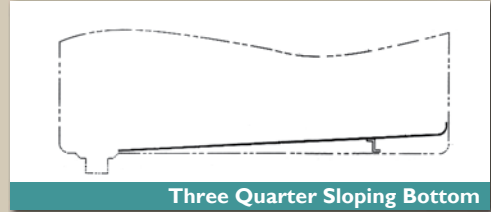

•Model PSS Stainless* •Model PSM Mild Steel*

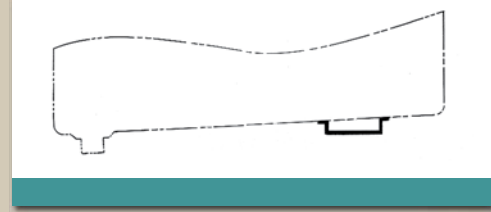

**Deduct approximately 8 gallons from standard sizes when selecting this option.*

Accessories

Standard 2" Fittings. Available in Stainless, Bronze, Black Iron & Galvanized
(Other types and sizes available)

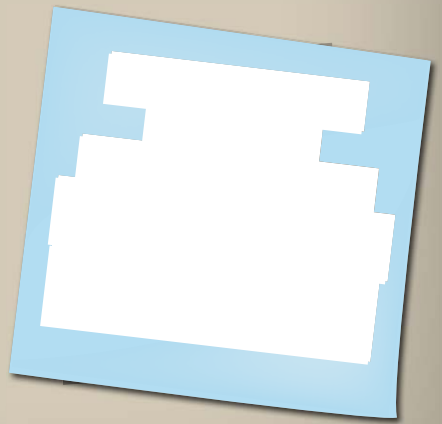
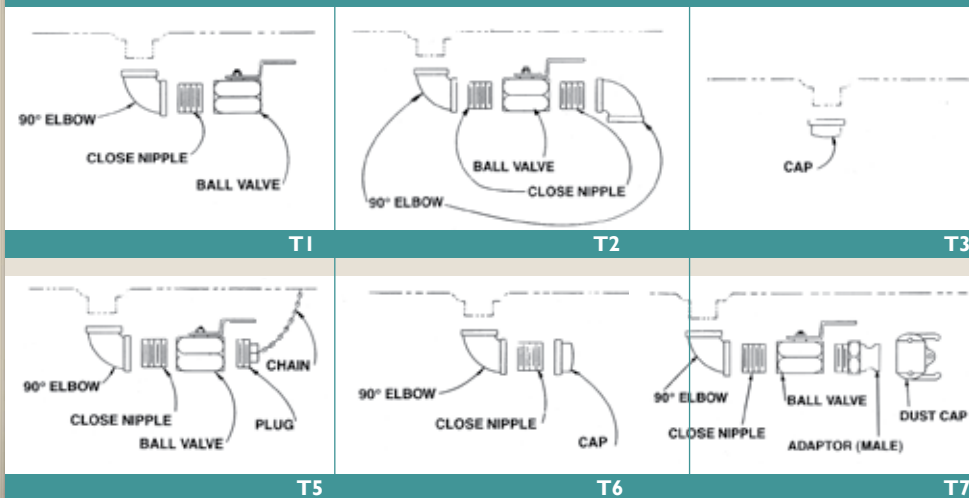

Dri-Pak Containers

- A** Standard 55 Gallon Drum Lid Opening
- B** Stacking Band
- C** Stacking Pad
- D** Heavy Gussets (for added Strength)
- E** Hopper Bottom Discharge
- F** Four Way Entry Fork Guides





Model X 45SS R 10 RB VS LS Z Z Z (shown with round butterfly valve)

- Choice of Valves (Butterfly, Iris, Slide Tray)
- Available in Mild or Stainless Steel
- Reduce product loss
- Reduce labor cost

- Utilize floor space
- Stackable
- Store indoors or outside
- 10 to 150 cu. ft. capacity

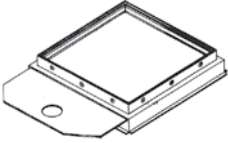
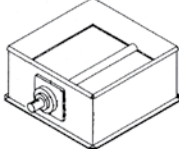
Accessories

ST (Slide Tray)	SB (Square Butterfly)	RB (Round Butterfly)	IF (Iris)
			
<ul style="list-style-type: none"> •Add #VC for Mild Steel •Add #VS for Stainless Steel •Std. Sizes 10", 12", 14", 16", 18" 	<ul style="list-style-type: none"> •Add #VC for Mild Steel •Add #VS for Stainless Steel •Std. Sizes 10", 12", 14", 16", 18" •Furnished with food approved gasket material 	<ul style="list-style-type: none"> •Add #VC for Mild Steel •Add #VS for Stainless Steel •Std. Sizes 6", 8", 10", 12", 14" 	<ul style="list-style-type: none"> •Add #VA for Aluminum •Add #VS for Stainless Steel •Std. Sizes 4", 6", 8", 10", 12" •4 oz. nylon sleeve is std.

Stainless Steel					
Model	Cap. Cu. Ft.	Approx. Height	Width	Length	Fork Gd. Opening
45SS	45	72	42	42	3 x 7
60SS	60	87	42	42	3 x 7
70SS	70	97	42	42	3 x 7
85SS	85	112	42	42	3 x 7

Mild Steel					
Model	Cap. Cu. Ft.	Approx. Height	Width	Length	Fork Gd. Opening
45MS	45	72	42	42	3 x 7
60MS	60	87	42	42	3 x 7
70MS	70	97	42	42	3 x 7
85MS	85	112	42	42	3 x 7

Hopper bottom supplied with 12" sqare flanged opening. (Other sizes and shapes available)

Model BD
(Bottom Vacuum Discharge)

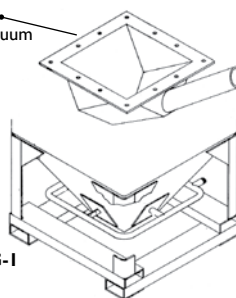

Model PRG-1
(Purge Pipe)

Model LL-1 (Lifting Lugs)

Model NP-2
(Top vent 2" nipple with cap)

Model SG-1
(Sight Glass)

Model SG-2
(Sight Glass)

Model VP 1/4"
(Vibrator Socket)

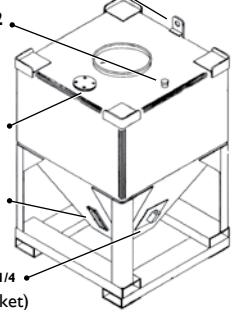

Liquid Container: How to Order

How to Order: X 336-42SS TI FS VS LS(1) IR PSS

For Options & Accessories see page 22.

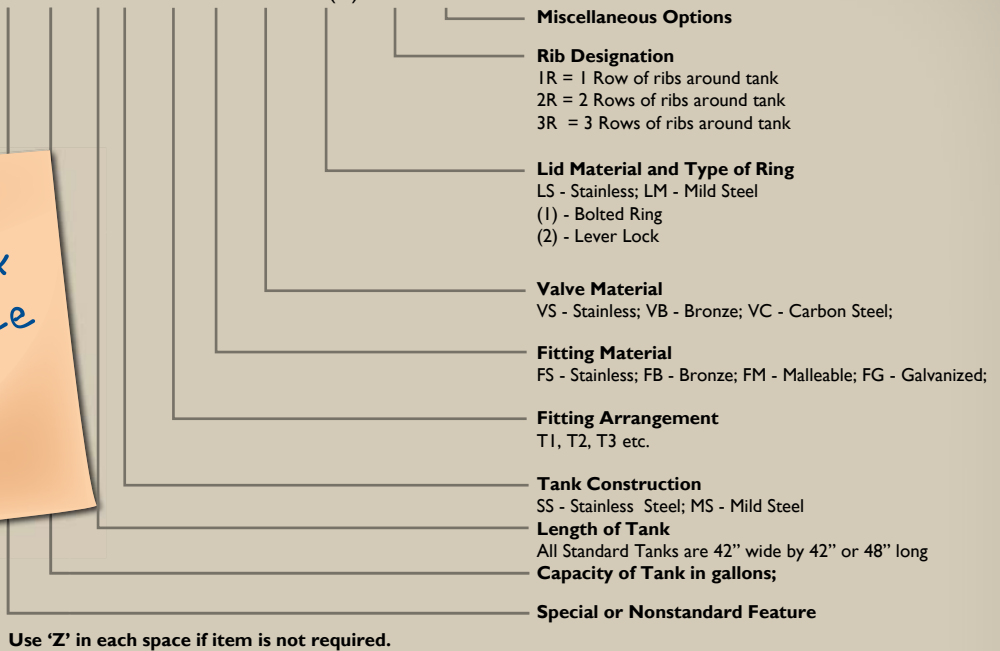

Dri-Pak Container: How to Order

How to Order: X 45 SS S 10 ST VS LS SGI

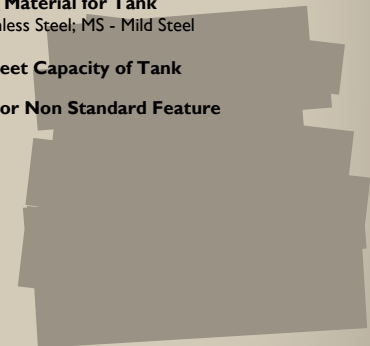
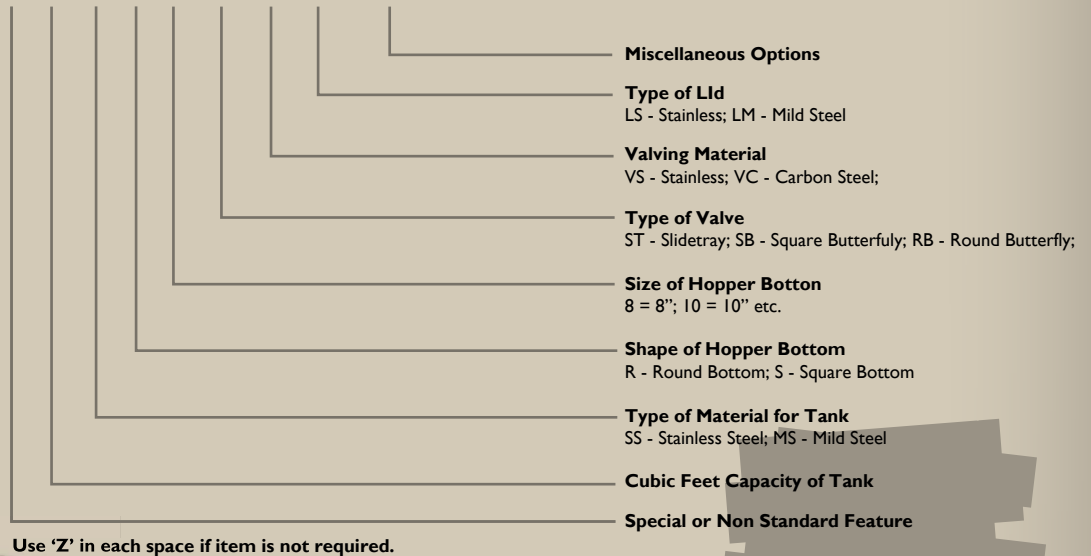

Platform Trucks

Light Duty
1,500 to 2,000 lbs.



286RR-A 2444

Standard deck sizes up to 30x56. Other sizes and capacities available upon request.

- Plated Casters (bolted on)
- Two Pockets for Removable Pipe Push Handle
- 14 GA. Type 304 SS Deck-2B finish

Mold-On Rubber Wheels				Plastic Wheels				Polyurethane Wheels			
Model	Cap. lbs.	Wheel Size	Approx. Deck Height	Model	Cap. lbs.	Wheel Size	Approx. Deck Height	Model	Cap. lbs.	Wheel Size	Approx. Deck Height
284RR	1,500	6 x 2	10"	284PR	2,000	6 x 2	10"	284UR	2,000	6 x 2	10"
286RR	2,000	8 x 2	12"	286PR	2,000	8 x 2	12"	286UR	2,000	8 x 2	12"

STANDARD OPTIONS AVAILABLE
ACCESSORIES & RACK OPTIONS - PG 11

Hand Trucks & Dollies



SS42-10NS



SS70-SH30 - 19" Dia.
SS70-SH55 - 24" Dia.



SS71-SH30 - 19" Dia.
SS71-SH55 - 24" Dia.

See Page 15 & 16
for stainless
trucks & dollies
specifications.

Dumping Buggy, Cure Tank & Chill Truck



DUMPING BUGGY

14 Gallon Type 304 stainless steel; 2B Finish
Full Rolled Top Ring
Special Cast Stainless Corners
Drip Guard
Easy to Clean - Rounded Corners
Ruggedly Constructed Wheel Mounting Base
All Interior Welds Heli-Arced and Blasted
Push Handle Option
Standard Sizes - 25" x 25" x 21" deep;
25 x 25 x 31 1/2" deep (400 and 600 lbs capacity)
Standard with (2)5" & (2)6" white plastic wheels
Other Sizes, Finishes and Wheel Types Available

MS400BU

CURE TANK

Constructed of 12 Gallon Type 304 Stainless Steel; 2B Finish
All Interior Welds Heli-Arced and Blasted
2" Radius Corners for Easy Cleaning
Completely Enclosed 10 Gallon Stainless Legs
Top Lip Hemmed and Continuously Welded
1 1/2" Tank Outlet with Guard
5 3/4" Underclearance
Standard Sizes - 48" x 42" x 36" deep and 48" x 36" x 36" deep
Other Sizes and Finishes Available



484236SSCT



SSIB355827

CHILL TRUCK

14 Gallon Type 304 stainless steel; 2B Finish
All Interior Welds Heli-Arced and Blasted
Easy to Clean - Rounded Corners
Bolted-On Plated Casters
Standard with 5" Plastic Wheels
Standard Size 35" x 58" x 27" deep (Approx. Inside Dimensions)
Half Rolled Top Lip
1 1/2" Bottom End Drain with Plug
1,600 lbs. Capacity
Other Sizes, Finishes and Wheel Types Available

Trailers

1. Type of Trailer

- a. Caster Steer 5th Wheel Steer 4 Wheel Steer
 b. Single End Double End

2. Quantity/Size & Size Limits/Capacity

_____ / _____ / _____

3. Type of Deck

- Wood Steel Open

4. What is the load and what are they doing with it?

5. Are there any overall restrictions (doorways, aisles, etc.)?

6. Conditions

- Rough Floors Smooth Floors Outdoors Railroad Tracts etc.
 Factory or Office etc. Dust or Moisture etc. Power Pulled Hand Pushed
 Ramps

7. Types of Wheels & Casters

8. Is there any Shock Loading? If yes, what is it?

9. Deck Height Limitations

10. Type of Pockets, Racks & Location:

11. If you need bumpers, what type? (see pg 11 for examples)

- a. Perimeter Corner Donut

12. Paint Color (Standard Blue or Custom Color)

13. How Fast, Far & Often are they pulling?

14. Coupler Type and Height Requirements:

1. Quantity/Size & Size Limits/Capacity

_____ / _____ / _____

2. Type of Deck

- Wood Steel Open

3. What is the load and what are they doing with it?

4. Are there any overall restrictions (doorways, aisles, etc.)?

5. Conditions

- Rough Floors Smooth Floors Outdoors Railroad Tracts etc.
 Factory or Office etc. Dust or Moisture etc. Power Pulled Hand Pushed
 Ramps

6. Types of Wheels & Casters

7. Is there any Shock Loading? If yes, what is it?

8. Deck Height Limitations

9. Options

- a. Non-Tilt Tilt
b. 4 Wheel 6 Wheel

10. Type of Pockets & Location:

11. Push Handle Required (type and quantity)? (see pg 11 for examples)

12. If you need bumpers, what type? (see pg 11 for examples)

- Perimeter Corner Donut

13. Paint Color (Standard Blue or Custom Color)

1. Quantity/Size & Size Limits/Capacity

_____ / _____ / _____

2. Deck Style

Standard Open Deck Expanded Metal Sheet Steel Plywood Wood Slat

3. What is the load and what are they doing with it?

4. Entry

2 Way 4 way

5. Fork dimensions (Length & Out to out forks)

6. Are fork stirrups required? If yes, what size and which forks?

7. Are Gussets Required? If yes, which side?

8. How high will racks be stacked?

9. Post Height:

10. Are side frames required? If yes, which sides and height?

11. Are channels collars required? If yes, who is furnishing plywood & which sides and size?

12. Target & Plugs:

Standard Reversed

13. Paint Color (Standard Blue or Custom Color)

14. Are they inter-stacking with anyone else's racks?

Custom Projects {1-2}

Trailers {3-8}

- Caster Steer Trailers 3
- Fifth Wheel Steer Trailers 4-6
- Wheels/Options 7
- Couplers 8

Platform Trucks {9-14}

- All Wood Deck 9
- Wood or Steel Deck - Steel Frame 10
- Nestable Trucks 11
- Rack Options & Accessories 11
- Wood or Steel Deck - Angle Frame 12
- Semi-Live Trucks 13
- Lift Units 13
- Miscellaneous Trucks 14

Dollies & Hand Trucks {15-17}

- Heavy Duty Industrial Hand Trucks 15
- Barrel Dollies 16
- Wood Dollies 17
- Steel Dollies 17
- Pry Trucks 17

Stack Racks {18-20}

- Parts Bin 18
- Coil Rack 18
- Modular Storage Rack 18
- Stack Racks 2000 & 4000 # cap. 19
- Rack Accessories 20

Tanks {21-24}

- Liqui-Tainer 21
- Tank Options & Accessories 22
- Dri-Pak Containers 23
- Dri-Pak Options & Accessories 23
- How to Order Tanks 24

Stainless Steel {25-26}

- Platform Truck 25
- Hand Trucks & Dollies 25
- Dumping Buggy 26
- Cure Tank 26
- Chill Truck 26

Product Checklists {27-29}

- Trailers 27
- Platform Trucks/General Products 28
- Stack Racks 29

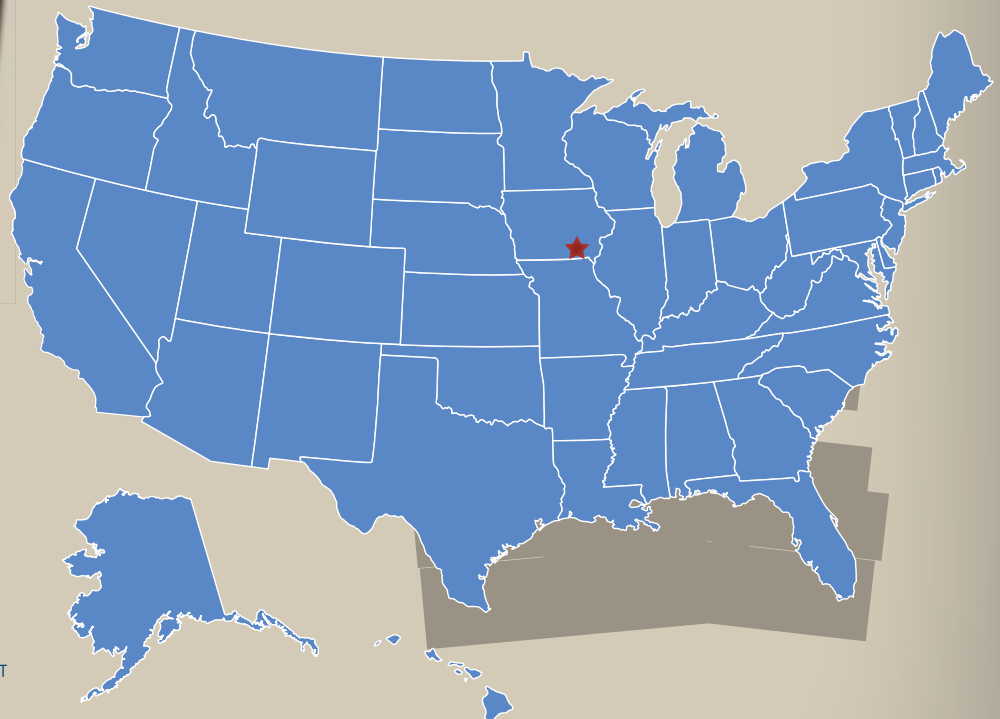
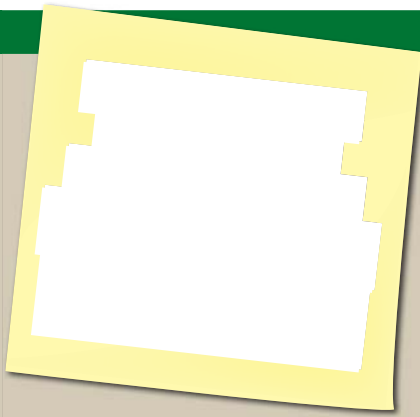

Order from:

Dick Jones Sales, Inc.
 258 Baltimore St. P.O. Box 141
 Hanover, PA 17331-0141
 P 800-441-9955
 F 800-253-4036
 Dickjones@dickjonesales.com