

CONTACT US! ALL PRICES WILL BE FURTHER DISCOUNTED!
CALL DICK JONES SALES 800-441-9955

EXCLUSIVE BRANDS!



ELITE
5500-Lb. Capacity
Pallet Trucks
See page 23



ELITE
High-Capacity Wire Shelving
See page 9



Relius solutions
Collapsible Wire Containers
See page 25



Relius solutions
60° Standard Slope Ladders
See page 15



Relius solutions
Flammable Liquids Safety Cabinets
See page 13



Relius solutions
Economic Tray-Shelf Carts
See page 33



Relius solutions
Convex Safety Mirrors
See page 17



Relius solutions
High-End Platform Trucks
See page 22



Relius solutions
Three-Rib Steel Protective Rail Systems
See page 14



Relius solutions
Mobile Computer Cabinets
See page 18



Relius solutions
Mechanical Mobile Scissor Lift Table
See page 24



Relius solutions
Boltless Shelving
See page 5



Relius solutions
1 1/2" Thick Butcher Block Maple Top Workbenches
See page 19



HERCULES
Work Platforms
See page 13



Relius solutions
Polyurethane Stools
Please Call!



Relius solutions
Hang & Stack Bins
See page 4



B



A



C

Perfo panel accessories not included.
Please call for hooks, clamps, etc.



HIGH-SECURITY HASP! Specially designed hardened steel hasp keeps the entire lock out of reach of bolt cutters & other cutting devices.

Relius solutions **Deep-Door Security Cabinets**

- 800-lb. capacity per shelf • 16-gauge steel
 - All-welded • Padlock hasp with single-point lock
- "Universal," all-in-one, premium-series cabinets store all your tools and supplies. High-security padlock hasp prevents cutting devices from reaching lock. 30 1/2" Wx16 7/8" Dx4" H, 75-lb. capacity drawers have 100% full-extension ball-bearing glides. Drawers may be divided into (16) 4x7 1/2" compartments with removable dividers provided. Removable Akro-Bins® hang from louvered panels. Made in USA. *IN STOCK.*

A. Four-Shelf Combination Cabinet

Features four shelf openings and (7) 4"D shelf openings per door.

Overall WxDxH	Stock No.	\$
36x24x72"	8413900-S	1672.00

Three-Drawer Cabinet with 118 Bins

(Cabinet not shown) Includes the following bins: (96) 5 3/8" Lx4 1/8" Wx3"H, (18) 10 7/8" Lx5 1/2" Wx5"H, (4) 14 3/4" Lx8 1/4" Wx7"H.

Overall WxDxH	Stock No.	\$
36x24x72"	8414000-V	2443.00

B. Four-Drawer Cabinet with 118 Bins

Includes the following bins: (96) 5 3/8" Lx4 1/8" Wx3"H; (18) 10 7/8" Lx5 1/2" Wx5"H; (4) 14 3/4" Lx8 1/4" Wx7"H.

Overall WxDxH	Stock No.	\$
36x24x72"	8414100-V	2758.00

C. Eight-Drawer Cabinet with 96 Bins

Includes (96) 5 3/8" Lx4 1/8" Wx3"H bins. 17 3/4" Wx34 1/2" H perfo panel accepts BOTT hooks and accessories.

Overall WxDxH	Stock No.	\$
36x24x72"	8414200-V	3381.00



HIGH-SECURITY HASP!
Specially designed hardened steel hasp keeps the entire lock out of the reach of bolt cutters and other cutting devices.



Ultra Deep-Door Security Bin Cabinets

- 14-gauge steel
- All-welded
- Padlock hasp with single-point lock

High-density storage cabinets feature 4"D pocket doors, adjustable leveling feet, and a high-security hasp. Unbreakable polypropylene bins are guaranteed for life. Cabinet holds: (48) 5³/₈"Lx4¹/₈"Wx3"H, (48) 7³/₈"Lx4¹/₈"Wx3"H, (12) 14³/₄"Lx8¹/₄"Wx7"H, (18) 10⁷/₈"Lx5¹/₂"Wx5"H, and (6) 14³/₄"Lx16¹/₂"Wx7"H bins. Gray enamel finish. Made in USA. *IN STOCK.*

Description	Overall WxDxH	Stock Number	\$ Reg.	\$ SALE
Cabinet with 132 Yellow Bins.	36x24x72"	8500127-T	1445.00	1250.00
Cabinet with 132 Blue Bins.	36x24x72"	8505227-T	1445.00	1250.00
Cabinet with bin slots only.	36x24x72"	8520027-T	967.00	850.00



All-Welded Combination Cabinets

- 1450-lb. capacity per shelf
- 14-gauge steel
- All-welded
- Three-point turn handle lock with 3/8" locking rods

Built to store and protect personal belongings and withstand tough industrial environments. Reinforced solid doors features a turn handle that locks door at 3 points using 3/8" diameter locking rods. Full-height door stiffeners provide rigid torque-free operation. Heavy-duty knuckle hinge is welded to the door and securely riveted to the frame. All-welded construction with strong 14-gauge sheet steel. Formed shelves adjust on 3" centers. Includes one-full-width adjustable shelf, three adjustable side shelves, and wardrobe bar. Made in USA. *FACTORY QUICK SHIP.*

Galvanite Corrosion-Resistant Combination Cabinets

Galvanneal steel is coated with zinc-iron alloy for extra protection in high-humidity and moist areas.

Combination Cabinets

Manufactured from prime grade cold rolled sheet steel.

Overall WxDxH	Shelf Openings	Stock Number	\$
36x24x78"	4 half/1 full	5922300-S	1302.00
48x24x78"	4 half/1 full	2301800-S	1371.00
60x24x78"	4 half/1 full	2301900-S	1481.00

Overall WxDxH	Shelf Openings	Stock Number	\$
36x24x78"	4 half/1 full	2302000-S	1008.00
48x24x78"	4 half/1 full	2302100-S	1097.00
60x24x78"	4 half/1 full	2302200-S	1185.00



HIGH SECURITY HASP!
Specially designed hardened steel hasp keeps entire lock protected from bolt cutters and other devices.



Available Colors

(18) blue
 (27) gray



Deep-Door Security Cabinets

- 200-lb. capacity per shelf • 16-gauge steel
- All-welded • Padlock hasp with single-point lock

Features (4) 38"Wx17"D interior shelves that adjust on 7¹/₂" centers, (6) 18"Wx4"D door shelves that adjust on 2" centers and a piece of 15"Wx33"H, 1/4" hole pegboard on each door. Door shelves support up to 50 lbs. each. Made in USA. *IN STOCK.*

Overall WxDxH	BLUE	GRAY	\$
	Stock No.	Stock No.	
38x17x72"	8510918-U	8510927-U	1191.00

8500718-T Extra Shelf. Color: blue. 38"Wx17"D. Pkg. of 2. \$89.00
 8500727-T Extra Shelf. Color: gray. 38"Wx17"D. Pkg. of 2. \$89.00



Ships same day for 1-3 day delivery

Ships 1-5 days



Relius Hang and Stack Bins

- Economical solution to small parts storage
- Polypropylene/polyethylene
- Stackable

All the strength and durability of competitor's bins at an affordable price. Tough bins resist cracks, water, and corrosion. Practical design includes: reinforced sidewalls to prevent spreading, extra wide ledge for secure stacking, rear hanger lip for racking, and large label slots for better identification of stored product. Interchangeable with other manufacturers' bins. Materials have been approved to meet FDA standards. Dividers sold separately. Order in carton quantities, priced each. Made in USA. *IN STOCK.*

Overall WxDxH	Ctn. Qty.	RED	YELLOW	BLUE	\$	Pkg. Qty.	BLACK	\$ Pkg.
		Stock Number	Stock Number	Stock Number			Stock Number	
		BINS						
4 ¹ / ₈ x5 ¹ / ₈ x3"	24	5997602-T	5997609-T	5997618-T	0.82	6	5994800-V	6.10
4 ¹ / ₈ x7 ¹ / ₈ x3"	24	5997702-T	5997709-T	5997718-T	1.15	6	5994900-V	6.80
5 ¹ / ₈ x10 ¹ / ₈ x5"	12	5997802-T	5997809-T	5997818-T	3.24	6	5995000-V	8.30
11x10 ¹ / ₈ x5"	6	5997902-T	5997909-T	5997918-T	4.97	6	5995100-V	8.30
8 ¹ / ₈ x14 ¹ / ₈ x7"	12	5999702-T	5999709-T	5999718-T	5.30	6	5995200-V	17.70
16 ¹ / ₂ x14 ¹ / ₈ x7"	6	5999902-T	5999909-T	5999918-T	9.10	6	5995200-V	17.70
					DIVIDERS			



5638802-S



5638827-S

Relius Tote with Attached Lid

- Injection-molded polyolefin
- Stack and nest
- Includes flip lid

Stacks and nests to allow the most efficient use of available storage or trailer space. Durable side walls are .001" thick making this container even more lightweight than comparable units. Features molded-in strapping notches on long side. Works well with most conveyor systems. Minimum order quantity is 4, priced each. Made in USA. *IN STOCK.*



Overall LxWxH	Cap. Cu. Ft.	RED	GRAY	\$
		Stock No.	Stock No.	
21.9x15.2x9.3"	1.4	5962602-S	5962627-S	13.30
21.8x15.8x12.9"	1.8	5638802-S	5638827-S	14.10
26.9x16.9x12.1"	2.4	5962702-S	5962727-S	23.30



- No Staples Or Tape
- Just Fold and They Hold
- 6 Widths, 12", 18" or 24" Depths
- Regular Or White Finish



Relius No-Spill 32-Lb. Test Bin Boxes

Heavy-test, corrugated fiberboard bin boxes assemble without staples or tape. Rear lip suspends bin from shelf above. 40% post-consumer on average. Made from recycled fiber, the correct choice for the environment. 32 lb. crush strength, your shipping standard. Order in quantities of 25, priced each. Made in USA. *IN STOCK.*



Removable inner bins are ideal for your smallest parts!

Overall WxDxH	REGULAR FINISH BINS			WHITE FINISH BINS		
	Stock Number	\$ (25+)	\$ (500+)	Stock Number	\$ (25+)	\$ (500+)
2x12x4 ¹ / ₂ "	4402900-W	0.84	0.80	4423000-W	0.78	0.75
4x12x4 ¹ / ₂ "	4400200-W	0.87	0.83	4423100-W	0.95	0.91
6x12x4 ¹ / ₂ "	4400300-W	0.80	0.76	4423200-W	0.90	0.86
8x12x4 ¹ / ₂ "	4400400-W	1.05	1.00	4423300-W	1.12	1.07
10x12x4 ¹ / ₂ "	4400500-W	1.21	1.15	4423400-W	1.40	1.33
12x12x4 ¹ / ₂ "	4400600-W	1.55	1.48	4423500-W	2.03	1.93
2x18x4 ¹ / ₂ "	4404200-W	0.90	0.86	4425100-W	1.20	1.14
4x18x4 ¹ / ₂ "	4400700-W	0.86	0.82	4425200-W	1.16	1.11
6x18x4 ¹ / ₂ "	4400800-W	1.05	1.00	4425300-W	1.57	1.50
8x18x4 ¹ / ₂ "	4400900-W	1.36	1.30	4425400-W	1.80	1.71
10x18x4 ¹ / ₂ "	4401000-W	1.60	1.52	4425500-W	1.86	1.77
12x18x4 ¹ / ₂ "	4401100-W	1.76	1.68	4425600-W	1.98	1.89
4x24x4 ¹ / ₂ "	4416000-W	1.09	1.04	4417000-W	2.75	2.62
6x24x4 ¹ / ₂ "	4416100-W	1.68	1.60	4417100-W	2.65	2.52
8x24x4 ¹ / ₂ "	4416200-W	1.59	1.52	4417200-W	2.43	2.31

4411000-W Removable Inner Bin. 1¹/₈"Wx3¹/₂"Dx4"H. Regular finish only. Sold in packages of 50. \$ Pkg./50 47.10. \$ (6+pkg./50).....44.80

Call for additional sizes and styles of bins.

Relius solutions Commercial Steel Shelving

- Light-Industrial: 14-gauge steel uprights; 22-gauge steel shelves
- Shelves attach to posts via clips
- Shelf capacity: 400 lbs., shelf capacity based on evenly distributed loads

Easy to assemble steel shelving is great for the garage, warehouse, store room, or shop. Sets up quickly without special tools. Shelves adjust in 1" increments to accommodate changing storage needs. Comes complete with everything you need including: shelves, four posts, back and side cross braces and hardware. Baked enamel finish in gray. Ships unassembled. Made in USA. **IN STOCK.**

Overall WxDxH	Shelf Cap. Lbs.	Shelf Qty.	Stock No.	\$
36x12x75"	400	5	6472000-U	96.00
36x18x75"	400	5	6472100-U	104.00



Clip-style shelves save set up time.



Shelves are bolted to posts.

Relius solutions Reinforced Bolted Shelving

- Ultra-Capacity: 13-gauge steel posts; 14-gauge steel shelves
- Shelf capacity: up to 2800 lbs., capacities based on evenly distributed loads
- Unassembled

Popular in the warehouse or shop, reinforced shelving is ideal for organized storage of heavy items. Extra-heavy gauge steel shelves feature a stiffener welded underneath to prevent deflection under heavy loads. Shelves adjust on 1" centers. Comes complete with 4 posts, 5 bolt-on shelves, and all hardware. Easy nut and bolt assembly sets up quickly. Gray powder coat finish. Ships unassembled. Made in USA. **FACTORY QUICK SHIP.**

Overall WxDxH	Shelf Cap. Lbs.	Shelf Qty.	Stock No.	\$
36x18x84"	2800	5	3064600-U	313.00
48x18x84"	2600	5	3064700-U	370.00
48x24x84"	2500	5	3064800-U	463.00
60x24x84"	2300	5	3064900-U	552.00
72x24x84"	2000	5	3065000-U	645.00



UP TO 2800-LB. SHELF CAPACITY

Relius solutions Boltless Shelving

- Ultra-Capacity: 14-gauge steel posts; 16-gauge steel shelves
- Shelf capacity: up to 4000 lbs., capacities based on evenly distributed loads
- Unassembled

Brace-free construction allows access to shelves from all sides. Boltless design offers simple assembly that requires no additional hardware. Shelves adjust in 1 1/2" increments along formed angle uprights. Overall capacity is 13,000 lbs. Tough powder coat finish. Color: gray. Made in USA. **SELECTED MODELS IN STOCK.**

Overall WxDxH	Shelf Cap. Lbs.	Shelf Qty.	Stock No.	\$
36x18x84"	4000	5	3014400-T	265.00
48x18x84"	4000	5	3014500-T	301.00
48x24x84"	4000	5	3014600-T	351.00
60x24x84"	3250	5	3014700-T	356.00
72x24x84"	2750	5	3014800-T	452.00
72x36x84"	2750	5	3014900-T	497.00
96x24x84"	2600	5	3015000-T	542.00
96x36x84"	2600	5	3015100-T	669.00
36x18x96"	4000	5	3015200-T	275.00
48x18x96"	4000	5	3015300-T	307.00
48x24x96"	4000	5	3015400-T	361.00
60x24x96"	3250	5	3015500-T	356.00
72x24x96"	2750	5	3015600-T	463.00
72x36x96"	2750	5	3015700-T	503.00
96x24x96"	2600	5	3015800-T	550.00
96x36x96"	2600	5	3015900-T	674.00



UP TO 4000-LB. SHELF CAPACITY



Double-rivet shelf connection



48"Wx24"Dx84"H unit shown.

Ships same day for 1-3 day delivery

Ships 1-5 days



Double-rivet connection



Relius Double-Rivet Shelving

- Standard-Industrial: 14-gauge steel posts; 16-gauge steel shelf levels
- Shelf capacity: up to 1500 lbs.; capacities are based on evenly distributed loads
- Shelf level quantity: 3
- Unassembled

Shelves adjust in 1/2" increments. Three decking choices: no decking; 3/8" thick 45-lb. high-density particleboard; or epoxy-coated 2x4" wire mesh. Tough powder coat finish. Color: gray. Made in USA. *IN STOCK.*

48x24x84" starter and add-on with particleboard decking, each with one extra level, shown.

Shelf Supports per Shelf Level	
36"W	1
48"W	1
60"W	1
72"W	2
96"W	3

Starters include: (4) angle posts and (3) shelf levels

Add-ons include: (2) T-posts and (3) shelf levels

All required shelf supports are included.

Assembly is simple. Just insert shelf rivets into adjacent T- or angle post slots. T-posts are used to add on extra units. Angle posts are used in starters and form add-on unit's corners.

Complete Units

Overall WxDxH	Shelf Cap. Lbs.	NO DECKING						PARTICLEBOARD DECKING					
		STARTER UNITS		ADD-ON UNITS		EXTRA LEVELS		STARTER UNITS		ADD-ON UNITS		EXTRA LEVELS	
		Stock No.	\$	Stock No.	\$	Stock No.	\$	Stock No.	\$	Stock No.	\$	Stock No.	\$
36x24x72"	1500	6005700-S	75.00	6008700-S	68.40	6039300-S	17.50	6012900-S	96.10	6017100-T	90.20	6020100-S	24.30
48x24x72"	1500	6005800-S	80.90	6008800-S	74.50	6039400-S	19.60	6013000-S	111.00	6017200-S	104.00	6020200-S	29.80
60x24x72"	1200	6005900-S	90.40	6008900-S	84.30	6039500-S	23.20	6013100-S	127.00	6017300-S	121.00	6020300-S	35.30
72x24x72"	1000	6006000-S	105.00	6009000-S	97.80	6039600-S	29.30	6013200-S	146.00	6017400-S	141.00	6020400-S	42.70
96x24x72"	800	6006100-S	126.00	6009100-S	121.00	6039700-S	36.40	6013300-S	179.00	6017500-S	173.00	6020500-S	54.20
48x36x72"	1500	6006200-S	89.20	6009200-S	83.00	6039800-S	22.20	6013400-S	136.00	6017600-S	129.00	6020600-S	37.40
60x36x72"	1200	6006300-S	98.40	6009300-S	92.20	6039900-S	27.20	6013500-S	151.00	6017700-S	145.00	6020700-S	43.60
72x36x72"	1000	6006400-S	119.00	6009400-S	111.00	6040000-S	33.10	6013600-S	177.00	6017800-S	172.00	6020800-S	53.00
96x36x72"	800	6006500-S	140.00	6009500-S	134.00	6040100-S	40.90	6013700-S	216.00	6017900-S	214.00	6020900-S	67.80
60x48x72"	1000	6006600-S	109.00	6009600-S	101.00	6040200-S	30.00	6013800-S	176.00	6018000-S	170.00	6021000-S	52.20
72x48x72"	800	6006700-S	129.00	6009700-S	124.00	6040300-S	37.60	6013900-S	211.00	6018100-S	203.00	6021100-S	64.30
96x48x72"	1000	6006800-S	153.00	6009800-S	146.00	6040400-S	45.50	6015200-S	255.00	6018200-S	254.00	6021200-S	81.40
36x24x84"	1000	6006900-S	78.60	6009900-S	75.00	6039300-S	17.50	6015300-S	101.00	6018300-S	98.30	6020100-S	24.30
48x24x84"	1500	6007000-S	84.40	6010000-S	77.40	6039400-S	19.60	6015400-S	114.00	6018400-S	107.00	6020200-S	29.80
60x24x84"	1200	6007100-S	94.40	6010100-S	86.90	6039500-S	23.20	6015500-S	125.00	6018500-S	123.00	6020300-S	35.30
72x24x84"	1000	6007200-S	110.00	6010200-S	101.00	6039600-S	29.30	6015600-S	149.00	6018600-S	143.00	6020400-S	42.70
96x24x84"	1000	6007300-S	130.00	6010300-S	123.00	6039700-S	36.40	6015700-S	182.00	6018700-S	176.00	6020500-S	54.20
48x36x84"	1500	6007400-S	92.70	6010400-S	85.70	6039800-S	22.20	6015800-S	135.00	6018800-S	128.00	6020600-S	37.40
60x36x84"	1200	6007500-S	103.00	6010500-S	95.20	6039900-S	27.20	6015900-S	152.00	6018900-S	148.00	6020700-S	43.60
72x36x84"	1000	6007600-S	122.00	6010600-S	113.00	6040000-S	33.10	6016000-S	182.00	6019000-S	174.00	6020800-S	53.00
96x36x84"	800	6007700-S	143.00	6010700-S	137.00	6040100-S	40.90	6016100-S	222.00	6019100-S	216.00	6020900-S	67.80
60x48x84"	1000	6007800-S	113.00	6010800-S	104.00	6040200-S	30.00	6016200-S	179.00	6019200-S	173.00	6021000-S	52.20
72x48x84"	800	6007900-S	135.00	6010900-S	126.00	6040300-S	37.60	6016300-S	213.00	6019300-S	205.00	6021100-S	64.30
96x48x84"	1000	6008000-S	157.00	6011000-S	149.00	6040400-S	45.50	6016400-S	264.00	6019400-S	255.00	6021200-S	81.40
60x36x96"	1200	6008100-S	109.00	6011100-S	97.80	6039900-S	27.20	6016500-S	159.00	6019500-S	151.00	6020700-S	43.60
72x36x96"	1000	6008200-S	126.00	6011200-S	119.00	6040000-S	33.10	6016600-S	183.00	6019600-S	177.00	6020800-S	53.00
96x36x96"	1000	6008300-S	148.00	6011300-S	139.00	6040100-S	40.90	6016700-S	226.00	6019700-S	219.00	6020900-S	67.80
60x48x96"	1000	6008400-S	119.00	6011400-S	107.00	6040200-S	30.00	6016800-S	184.00	6019800-S	175.00	6021000-S	52.20
72x48x96"	800	6008500-S	138.00	6011500-S	129.00	6040300-S	37.60	6016900-S	218.00	6019900-S	208.00	6021100-S	64.30
96x48x96"	1000	6008600-S	161.00	6011600-S	152.00	6040400-S	45.50	6017000-S	268.00	6020000-S	258.00	6021200-S	81.40



Beam-hook connection



72x36x72" starter with steel deck shown.



Bulk Racks with Welded Upright Frames

- **Standard-Industrial:** 14-gauge steel upright frame; 14-gauge steel beam
- **Beam-hook connection**
- **Shelf capacity:** up to 4000 lbs.; capacities based on evenly distributed loads
- **Shelf level quantity:** 3
- **Welded upright frame**

1³/₈"x2", all-welded upright frame is punched on 2" centers. Z-shape beam design increases capacity. Shelf levels adjust in 2" increments. Three decking choices: economical 5/8" thick high-density particleboard; epoxy-coated wire mesh; or ribbed 20-gauge steel with 1¹/₈"W recesses that allow you to easily grab inventory. Starters can be used individually or combined with add-ons to complete a row of shelving. Beams and upright frames will not interchange with EDSAL bulk rack manufactured before 1999. Gray powder coat finish. Made in USA. **IN STOCK.**



PARTICLEBOARD DECKING

Overall WxDxH	Shelf Cap. Lbs.	PARTICLEBOARD DECKING					
		STARTER UNITS		ADD-ON UNITS		EXTRA LEVELS	
		Stock No.	\$	Stock No.	\$	Stock No.	\$
60x24x72"	4000	5756603-T	279.00	5788003-T	232.00	5769403-T	61.10
72x24x72"	3500	5756903-T	299.00	5788103-T	252.00	5769703-T	67.10
96x24x72"	2800	5757003-T	349.00	5788203-T	301.00	5776203-T	84.00
60x36x72"	4000	5757103-T	314.00	5788903-T	263.00	5769503-T	70.00
72x36x72"	3500	5757203-T	336.00	5789003-T	285.00	5769803-T	76.30
96x36x72"	2800	5757303-T	397.00	5789103-T	337.00	5776403-T	97.30
60x24x96"	4000	5757803-T	296.00	5788303-T	241.00	5769403-T	61.10
72x24x96"	3500	5757903-T	314.00	5788403-T	258.00	5769703-T	67.10
96x24x96"	2800	5763403-T	365.00	5788503-T	308.00	5776203-T	84.00
60x36x96"	4000	5763503-T	331.00	5789203-T	271.00	5769503-T	70.00
72x36x96"	3500	5763603-T	354.00	5789303-T	293.00	5769803-T	76.30
96x36x96"	2800	5763703-T	416.00	5789403-T	355.00	5776403-T	97.30
60x48x120"	4000	5765803-T	393.00	5793603-T	309.00	5769603-T	79.40
72x48x120"	3500	5765903-T	406.00	5793803-T	337.00	5769903-T	87.40
96x48x120"	2800	5766203-T	479.00	5793903-T	411.00	5776503-T	114.00



Starters include: (2) upright frames and (3) shelf levels



Add-ons include: (1) upright frame and (3) shelf levels

Shelf Supports per Shelf Level

- 60"W.....1
 - 72"W.....2
 - 96"W.....3
- All required shelf supports are included.

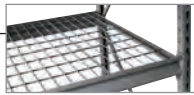

WIRE DECKING



STEEL DECKING

Overall WxDxH	Shelf Cap. Lbs.	WIRE DECKING						STEEL DECKING					
		STARTER UNITS		ADD-ON UNITS		EXTRA LEVELS		STARTER UNITS		ADD-ON UNITS		EXTRA LEVELS	
		Stock No.	\$	Stock No.	\$	Stock No.	\$	Stock No.	\$	Stock No.	\$	Stock No.	\$
60x24x72"	4000	—	—	—	—	—	—	5756602-T	357.00	5788002-T	309.00	5769402-T	87.10
72x24x72"	3500	6029400-T	359.00	6031300-T	312.00	6032300-T	94.10	5756902-T	388.00	5788102-T	342.00	5769702-T	98.20
96x24x72"	2800	6029500-T	447.00	6031400-T	403.00	6032400-T	121.00	5757002-T	459.00	5788202-T	412.00	5776202-T	123.00
60x36x72"	4000	—	—	—	—	—	—	5757102-T	414.00	5788902-T	364.00	5769502-T	104.00
72x36x72"	3500	6029600-T	442.00	6031500-T	392.00	6032500-T	115.00	5757202-T	453.00	5789002-T	402.00	5769802-T	119.00
96x36x72"	2800	6029700-T	528.00	6031600-T	479.00	6032600-T	145.00	5757302-T	540.00	5789102-T	488.00	5776402-T	147.00
60x24x96"	4000	—	—	—	—	—	—	5757802-T	374.00	5788302-T	318.00	5769402-T	87.10
72x24x96"	3500	6029800-T	375.00	6031700-T	320.00	6032300-T	94.10	5757902-T	405.00	5788402-T	351.00	5769702-T	98.20
96x24x96"	2800	6029900-T	464.00	6031800-T	410.00	6032400-T	121.00	5763402-T	475.00	5788502-T	419.00	5776202-T	123.00
60x36x96"	4000	—	—	—	—	—	—	5763502-T	429.00	5789202-T	371.00	5769502-T	104.00
72x36x96"	3500	6030000-T	459.00	6031900-T	402.00	6032500-T	115.00	5763602-T	469.00	5789302-T	415.00	5769802-T	119.00
96x36x96"	2800	6030100-T	553.00	6032000-T	487.00	6032600-T	145.00	5763702-T	563.00	5789402-T	497.00	5776402-T	147.00
60x48x120"	4000	—	—	—	—	—	—	5765802-T	500.00	5793602-T	430.00	5769602-T	121.00
72x48x120"	3500	6031100-T	545.00	6032100-T	475.00	6032700-T	137.00	5765902-T	548.00	5793802-T	478.00	5769902-T	138.00
96x48x120"	2800	6031200-T	628.00	6032200-T	545.10	6032800-T	170.00	5766202-T	654.00	5793902-T	585.00	5776502-T	173.00

Ships same day for 1-3 day delivery

Ships 1-5 days



Relius
solutions
Wire Shelving

- Shelves slide over split sleeves along grooved 1" dia. posts
- 2-piece post on 63", 72" or 86"H posts
- Up to 48"W shelf capacity: 800 lbs; over 48"W shelf capacity: 600 lbs.; capacities based on evenly distributed loads
- Chrome finish

Shelves adjust at 1" increments. Optional clamps join shelving together to form rows. NSF certified. *IN STOCK.*

Two shelving units connected with clamps shown: one 36"Wx24"Dx72"H shelving unit with optional shelf dividers and back and side ledges and one 48"Wx24"Dx72"H shelving unit.

Additional components available—please call.



Post Sleeves

Snap into place.

Pkg. of 4.

5681600-T \$ Pkg.....2.85



Post Clamps

Join shelving units together for maximum strength.

5681700-W \$3.81



High-Capacity S-Hooks

Provides connection between starter and add-on shelves.

Use two per shelf.

5877700-T \$1.89

Overall WxDxH	Shelf Cap. Lbs.	Shelf Qty.	COMPLETE UNITS		EXTRA SHELVES	
			Stock No.	\$	Stock No.	\$
24x18x72"	800	4	6042900-S	126.00	5879900-T	26.20
36x18x72"	800	4	5679900-V	131.00	5681100-W	28.80
48x18x72"	800	4	5680000-U	163.00	5681200-W	37.70
60x18x72"	600	4	6043000-S	212.00	5876600-T	50.10
72x18x72"	600	4	6043100-S	244.00	5876700-T	59.40
24x24x72"	800	4	6043200-S	212.00	5878500-T	25.00
36x24x72"	800	4	6043300-S	166.00	5876800-T	37.20
48x24x72"	800	4	5680100-U	200.00	5681300-W	48.20
60x24x72"	600	4	5680200-U	235.00	5681400-W	59.20
72x24x72"	600	4	5680300-U	268.00	5681500-W	71.80
24x18x86"	800	4	6043400-S	132.00	5879900-T	26.20
36x18x86"	800	4	6043500-S	128.00	5681100-W	28.80
48x18x86"	800	4	6043600-S	151.00	5681200-W	37.70
60x18x86"	600	4	6043700-S	217.00	5876600-T	50.10
72x18x86"	600	4	6043800-S	250.00	5876700-T	59.40
24x24x86"	800	4	6043900-S	218.00	5878500-T	25.00
36x24x86"	800	4	6044000-S	172.00	5876800-T	37.20
48x24x86"	800	4	6044100-S	186.00	5681300-W	48.20
60x24x86"	600	4	6044200-S	371.00	5681400-W	59.20
72x24x86"	600	4	5680400-U	289.00	5681500-W	71.80
36x30x86"	800	3	5154800-V	216.00	5648500-T	54.90
48x30x86"	800	3	5154900-V	257.00	5648600-T	68.10
60x30x86"	600	3	5170100-V	329.00	5170900-T	91.10
72x30x86"	600	3	5170200-V	364.00	5648800-T	105.00
36x36x86"	800	3	5155000-V	245.00	5648900-T	62.80
48x36x86"	800	3	5156300-V	295.00	5649500-S	78.80
60x36x86"	600	3	5170300-V	360.00	5171100-T	104.00
72x36x86"	600	3	5170400-V	410.00	5171200-T	136.00

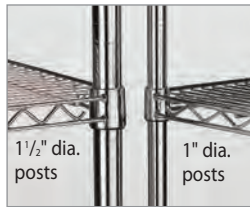

ELITE

High-Capacity Wire Shelving

- Shelves slide over split sleeves along 1 1/2" dia. grooved posts
- Shelf capacity: up to 2000 lbs., capacities based on evenly distributed loads
- Chrome or epoxy over zinc finish

Robust 1 1/2" diameter posts offer extra strength and support. Sets up without tools. Shelves adjust in 1" increments. Stationary posts include leveling glides. Post clamps connect complete units together to form rows. Optional mobile posts accept casters to create rolling units. **IN STOCK. IN STOCK.**

Complete Shelving Systems

Include 4 stationary posts and 4 shelves.

Overall WxDxH	Shelf Cap. Lbs.	Shelf Qty.	BLUE	CHROME	\$
			Stock Number	Stock Number	
36x18x63"	2000	4	5676318-W	5676341-W	222.00
48x18x63"	2000	4	5676418-W	5676441-W	272.00
60x18x63"	1500	4	5676518-W	5676541-W	289.00
48x24x63"	2000	4	5676618-W	5676641-W	316.00
60x24x63"	1500	4	5676718-W	5676741-W	365.00
72x24x63"	1500	4	5676818-W	5676841-W	451.00
36x18x74"	2000	4	5676918-W	5676941-W	232.00
48x18x74"	2000	4	5677018-W	5677041-W	279.00
60x18x74"	1500	4	5677118-W	5677141-W	303.00
48x24x74"	2000	4	5677218-W	5677241-W	327.00
60x24x74"	1500	4	5677318-W	5677341-W	386.00
72x24x74"	1500	4	5677418-W	5677441-W	465.00
36x18x86"	2000	4	5677518-W	5677541-W	249.00
48x18x86"	2000	4	5677618-W	5677641-W	299.00
60x18x86"	1500	4	5677718-W	5677741-W	316.00
48x24x86"	2000	4	5677818-W	5677841-W	341.00
60x24x86"	1500	4	5677918-W	5677941-W	386.00
72x24x86"	1500	4	5678018-W	5678041-W	486.00



Components:



1 1/2" Dia. Post Sleeves

5675500-W Pkg. of 4.
\$ pkg.....2.34

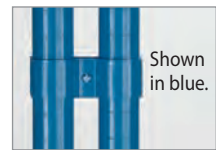

1 1/2" Dia. Post Clamps

5675600-W Chrome. \$.....4.00
5675700-W Blue. \$.....4.00

Call for wire shelving component parts.

Relius
solutions

PVC Shelf Liners for 1" Dia. Post Shelving

- Thickness: 3 mm

Fits standard collar-style shelving with 1" dia. posts. Sold in packs of 2. Made in USA. Specify color: (02) red, (18) blue, (27) gray, (29) black, (30) white. **IN STOCK.**

Overall WxD	Stock No.	\$ Pk.
36x18"	55611-S	45.70
36x24"	55612-S	56.90
48x18"	55614-S	54.70
48x24"	55615-S	69.40
60x18"	55616-S	79.00
60x24"	55617-S	88.00
72x18"	55766-S	80.40
72x24"	55767-S	107.00

Also available in:

- (18) blue
- (27) gray
- (29) black
- (30) white

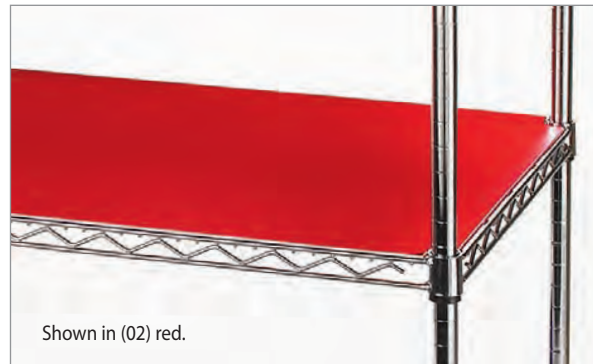

Shown in (02) red.

Ships same day for 1-3 day delivery

Ships 1-5 days



Relius
solutions **Vertical Bar Rack**

- 6000-lb. overall capacity
- 4 bays
- 1500-lb. capacity per bay
- All-welded

Stores long pieces vertically for better access. Bays are 10 1/2" wide. Includes security chain and hooks. Powder coat finish. Made in USA. **IN STOCK.**

Overall WxDxH	Stock Number	\$
48x24x60"	7665200-U	364.00



Order platform and uprights separately.

Relius
solutions **Premium Panel/Sheet Trucks**

- 1200 and 2000-lb. capacities
- Uprights are spaced 3 1/2" apart
- 12", 26", or 38" high uprights

Transports and stores multiple sizes of sheet and panel stock. Rugged 3/4" thick layered seamless wood deck is mounted into a rigid all-welded 1/2x1 1/2" angle iron frame. Strong base frames have rounded edges. Deck features a durable, non-mar lacquered finish. 24" model has 7 pockets, 30" has 9 pockets. Two rigid, two swivel casters. Order upright frames separately. German Engineered. Made in USA. **IN STOCK.**

PLATFORM ONLY. Specify casters: (01) 5" polyurethane, (02) 8" mold-on, (03) 8" pneumatic.

Deck LxW	Stock Number	(01) POLYURETHANE		(02) MOLD-ON RUBBER		(03) PNEUMATIC	
		Deck Height	\$	Deck Height	\$	Deck Height	\$
48x24"	70526-T	8"	349.00	11"	377.00	10.75"	383.00
60x30"	70527-T	8"	429.00	11"	455.00	10.75"	462.00

UPRIGHTS ONLY. Sold in pairs. Specify height: (12) 12"H, (26) 26"H, (38) 38"H.

Overall Length	Stock Number	(12) 12"H		(26) 26"H		(38) 38"H	
		\$	\$	\$	\$		
48"	70530-T	109.00	112.00	124.00			
60"	70531-T	106.00	109.00	122.00			



Portable Stacking Racks

- 10-13-gauge tubular steel
- 2000- and 4000-lb. capacities
- All-welded base

Assembles and stacks quickly right out of the box! May be stacked up to 4 high. Four-way fork truck entry. 4 1/2" underclearance. Available with 1x6" sturdy decking or without. Build your own racks from components listed below or order complete units. Made in USA.

Complete Units

Includes (4) 48"H stacking posts, (4) sockets and base frame. 4000-lb. capacity.

Overall LxWxH	BASE WITH DECKING (1x6" boards)		BASE WITHOUT DECKING	
	Stock No.	\$	Stock No.	\$
48x48x48"	7316400-S	427.00	7316500-S	331.00
60x48x48"	7318500-S	425.00	7318600-S	398.00

4,000-Lb. Capacity Components

10-gauge steel. Deck and posts sold separately.

Overall LxW	BASE WITH DECKING (1x6" boards)		BASE WITHOUT DECKING	
	Stock No.	\$	Stock No.	\$
48x42"	7316900-S	257.00	7321000-S	231.00
60x42"	7317000-S	276.00	7321100-S	233.00
48x48"	7318800-S	276.00	7322300-S	237.00
60x48"	7318700-S	291.00	7323900-S	250.00

2.170" square tube posts with 2 1/2" square sockets.

7336100-S	36"H, 10-gauge post. (4/set).	\$ Set	108.00
7336500-S	42"H, 10-gauge post. (4/set).	\$ Set	116.00
7338700-S	48"H, 10-gauge post. (4/set).	\$ Set	123.00

2,000-Lb. Capacity Components

13-gauge steel. Deck and posts sold separately.

Overall LxW	BASE WITH DECKING (1x6" boards)		BASE WITHOUT DECKING	
	Stock No.	\$	Stock No.	\$
48x42"	7318900-S	237.00	7319300-S	194.00
60x42"	7319000-S	273.00	7319400-S	216.00
48x48"	7319100-S	241.00	7319500-S	204.00
60x48"	7319200-S	252.00	7319600-S	215.00

1 1/2" square tube posts with 1 3/4" square sockets.

7331000-S	36"H, 13-gauge post. (4/set).	\$ Set	92.70
7331400-S	42"H, 13-gauge post. (4/set).	\$ Set	120.00
7331500-S	48"H, 13-gauge post. (4/set).	\$ Set	122.00

60" posts available on request.



Standard-Industrial Grade Cantilever Racks

- Single-sided column capacity: up to 8100 lbs.
- Double-sided column capacity: up to 16200 lbs.
- Arm capacity: up to 1000 lbs.
- 6', 8', and 10' heights

Choose either a complete system or build your own from the available components. Uprights facilitate manual loading and unloading. 12-gauge steel columns. Arms adjust on 3" centers. Capacities are based on evenly distributed loads. Gray enamel finish. Made in USA.

Components

Columns. 12-gauge steel. Includes hardware. Ships assembled.

Overall Height	For Arm Length	SINGLE-SIDED COLUMN			DOUBLE-SIDED COLUMN		
		Base Depth	Stock Number	\$	Base Depth	Stock Number	\$
6'	12" (8100-lb. cap.)	33"	7358100-S	220.00	54"	7359500-S	254.00
	18" (6600-lb. cap.)						
	24" (5500-lb. cap.)						
6'	30" (4700-lb. cap.)	45"	7358200-S	232.00	78"	7359600-S	281.00
	36" (4100-lb. cap.)						
	42" (3700-lb. cap.)						
6'	48" (3300-lb. cap.)	57"	7358300-S	254.00	102"	7359700-S	337.00
	48" (3300-lb. cap.)						
8'	12" (7600-lb. cap.)	33"	7358700-S	243.00	54"	7363100-S	279.00
	18" (6300-lb. cap.)						
	24" (5300-lb. cap.)						
8'	30" (4500-lb. cap.)	45"	7358800-S	248.00	78"	7363500-S	303.00
	36" (4000-lb. cap.)						
	42" (3600-lb. cap.)						
8'	48" (3200-lb. cap.)	57"	7358900-S	277.00	102"	7369500-S	356.00
	48" (3200-lb. cap.)						
10'	12" (7100-lb. cap.)	33"	7359200-S	261.00	54"	7369600-S	301.00
	18" (5900-lb. cap.)						
	24" (5000-lb. cap.)						
10'	30" (4000-lb. cap.)	45"	7359300-S	276.00	78"	7369700-S	326.00
	36" (3800-lb. cap.)						
	42" (3400-lb. cap.)						
10'	48" (3100-lb. cap.)	57"	7359400-S	299.00	102"	7369800-S	380.00
	48" (3100-lb. cap.)						

NOTE: Double column capacity is twice the corresponding single column capacity.

Straight Arms. Includes pin assembly.

Arm Length	Arm Cap. Lbs.	WITH LIP		WITHOUT LIP	
		Stock No.	\$	Stock No.	\$
12"	1000	7369901-S	26.10	7369902-S	26.10
18"	750	7370001-S	28.00	7370002-S	28.00
24"	600	7370101-S	30.00	7370102-S	30.00
30"	500	7370701-S	34.80	7370702-S	34.80
36"	400	7371001-S	36.70	7371002-S	36.70
48"	300	7377001-S	47.60	7377002-S	47.60

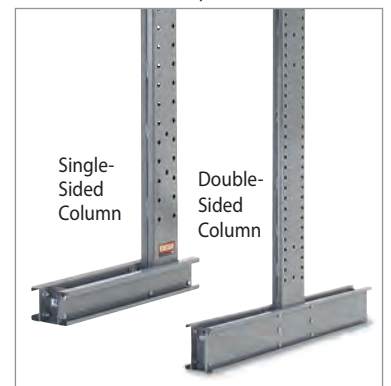
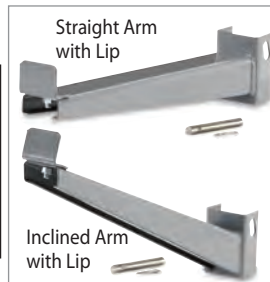

Inclined Arms. Includes pin assembly.

Arm Length	Arm Cap. Lbs.	WITH LIP		WITHOUT LIP	
		Stock No.	\$	Stock No.	\$
12"	1000	7377301-S	28.10	7377302-S	28.10
18"	750	7379301-S	30.60	7379302-S	30.60
24"	600	7379401-S	33.10	7379402-S	33.10
30"	500	7379701-S	39.00	7379702-S	39.00
36"	400	7379801-S	40.60	7379802-S	40.60
48"	300	7380001-S	49.10	7380002-S	49.10

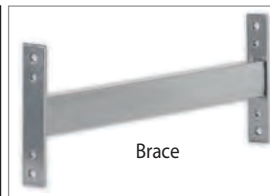

Brace Sets for Columns
Includes hardware. One set of braces is required for column heights up to 10'. Sold in sets of 2.

Brace Width	Stock Number	\$ Set
3'	7380100-S	70.60
4'	7380200-S	81.90
5'	7380300-S	92.90
6'	7380400-S	106.00
8'	7380500-S	129.00

Complete Cantilever Systems. Includes straight arms without lip and hardware. Ships unassembled.

Overall Height	Base Depth	Cap. Lbs.	Arm Cap. Lbs.	Brace Width	STARTER			ADD-ON		
					Arm Length	Stock No.	\$	Arm Length	Stock No.	\$
SINGLE-SIDED COLUMN										
6'	33"	8100	1000	(Set of 2) 4'	(6) at 12"	7668200-S	559.00	(3) at 12"	7668300-S	316.00
8'	33"	5300	600	(Set of 2) 4'	(8) at 24"	7668400-S	661.00	(4) at 24"	7668500-S	367.00
DOUBLE-SIDED COLUMN										
6'	54"	16200	1000	(Set of 2) 4'	(12) at 12"	7668600-S	757.00	(12) at 12"	7668700-S	402.00
8'	54"	10600	600	(Set of 2) 4'	(16) at 24"	7668800-S	931.00	(8) at 24"	7668900-S	503.00

Ships same day for 1-3 day delivery

Ships 1-5 days

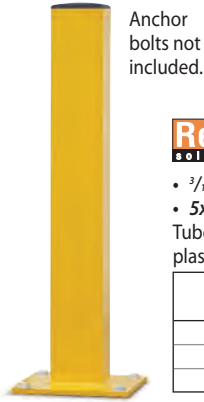

Anchor bolts not included.

Relius
solutions™ **Steel Safety Bollards**

- 3/16" thick steel tube
- 5x5" overall

Tube is welded to a 11x11" baseplate and topped with a black plastic cap. Yellow paint finish. Made in USA. *IN STOCK.*

Overall Height	Overall WxD	Stock Number	\$
24"	5x5"	7683100-T	133.00
36"	5x5"	7683200-T	160.00
42"	5x5"	7683300-T	175.00



Includes mounting hardware.

Relius
solutions™ **Steel Rack Protector**

- .1345" thick, 10-gauge steel
 - Fits up to a 4" wide upright
- Bright yellow and black safety tape surrounds this rack protector for better visibility. Mounting hardware included. Made in USA. *IN STOCK.*



Fits Upright Width	Overall Height	Baseplate WxD	Stock Number	\$	\$ (12+)
3.5"	12"	8x5.5"	5183300-U	36.30	34.50
4"	12"	4.75x3.08"	3065300-U	101.00	96.00
4"	18"	4.75x3.08"	3065200-U	90.00	85.50
4"	24"	4.75x3.08"	3065100-U	95.00	90.30



Includes removable handle for portability.

7870401-V

7870602-V

Relius
solutions™ **ELITE™**

100,000-Lb. Capacity Trailer Jacks

- 100,000-lb. static capacity
- Spin or ratchet lift
- 10" solid rubber or urethane foam-filled wheels

8" dia. self-leveling top plate. Triangular 1/2" thick steel base plate. *IN STOCK.*

Lifting Cap. Lbs.	Overall Height	Top Plate Type	RELIUS SOLUTIONS			RELIUS ELITE™		
			Wheel Type	Stock No.	\$	Wheel Type	Stock No.	\$
40,000	41-50 1/2"	Round with spin lift	Solid rubber	7870401-V	365.00	Urethane Foam Filled	7870402-V	391.00
50,000	41-50 1/2"	Round with spin lift	Solid rubber	7870501-V	434.00	Urethane Foam Filled	7870502-V	460.00
40,000	39 1/2-51"	Round with ratchet lift	Solid rubber	7870601-V	410.00	Urethane Foam Filled	7870602-V	433.00
50,000	39 1/2-51"	Round with ratchet lift	Solid rubber	7870701-V	481.00	Urethane Foam Filled	7870702-V	507.00
40,000	45-57"	Round with ratchet lift	Solid rubber	7870801-V	422.00	Urethane Foam Filled	7870802-V	446.00
50,000	45-57"	Round with ratchet lift	Solid rubber	7870901-V	495.00	Urethane Foam Filled	7870902-V	519.00

Relius
solutions™

Outrigger Drum Dolly

- Steel
- 1000-lb. capacity
- 23 1/4" inside diameter

Protective steel outriggers over each caster extend caster base for added stability. All-welded frame includes four replaceable bolt-on swivel casters. 2 1/2" D lip. Orange enamel finish. Made in USA. *IN STOCK.*



Fits Drum Cap. Gal.	Inside Dia.	Wheel Height	Wheel Type	Stock Number	\$
30, 55	23 1/4"	3"	Polyolefin	7665600-U	102.00

Relius
solutions™

8-Wheel Drum Dolly

- Steel
- 2000-lb. capacity
- 24" inside diameter

Eight casters smoothly transport your load. 26 7/8" dia. x 7" H overall. All-welded. Color: orange. Made in USA. *IN STOCK.*



Fits Drum Cap. Gal.	Inside Dia.	Wheel Height	Wheel Type	Stock Number	\$
55	24"	4"	Cast iron	7842900-S	141.00

Relius
solutions™

Heavy-Duty Drum Dolly

- Steel
- 2000-lb. capacity
- 25 1/4" inside diameter

All-welded. 25 1/4" dia. x 7 1/8" H overall. Color: orange. Made in USA. *IN STOCK.*



Fits Drum Cap. Gal.	Inside Dia.	Wheel Height	Wheel Type	Stock Number	\$
55	23 1/4"	4"	Phenolic	7842800-S	112.00



Cutaway view of urethane foam-filled wheel.

3264000-T shown with 3264600-T hinged door kit and optional 3264300-T rear tool tray and 3264400-T side tool tray, all sold separately.



3264000-T shown with 3264500-T chain gate kit sold separately.



3264000-T shown with 3264600-T hinged door kit and optional 3264300-T rear tool tray and 3264400-T side tool tray, all sold separately.

HERCULES Work Platforms

- Round tube construction
- 1000-lb. capacity
- Unassembled

Heavy-duty 11-gauge steel deck with anti-slip tread plate surface. 4" H toe board surrounds the entire deck. 42" H handrails and safety mesh on forklift side. Safety chain secures unit to forklift. Chain gate or hinged door must be purchased separately. Meets OSHA/ANSI standards. Ships unassembled—easy to assemble or disassemble for compact storage. Made in USA.

Overall WxD	WORK PLATFORM		CHAIN GATE KIT		HINGED DOOR KIT		BACK RISER	
	Stock No.	\$	Stock No.	\$	Stock No.	\$	Stock No.	\$
36x36"	3264000-T	474.00	3264500-T	35.00	3264600-T	48.10	3265200-T	75.00
36x48"	3264100-T	491.00	3264700-T	35.00	3264800-T	48.10	3265300-T	75.00
40x48"	3264200-T	510.00	3264900-T	37.50	3265000-T	53.90	3265400-T	78.90

3264300-T Rear tool tray. For use with 36"W platforms. \$.....86.60
 3264400-T Side tool tray. \$86.60
 3265500-T Metal light bulb caddy. \$81.70

Flammable Liquids Safety Cabinets

- Flush-mount handle with 3-point latch
- 350-lb. capacity per shelf
- "FLAMMABLE KEEP FIRE AWAY" warning label

16-gauge steel cabinet features 1 1/2" air space. Other features include: dual 2" capped vents with flash arrestors, adjustable shelves, 2"H leakproof door sill, and adjustable leveling feet. FM Approved. Meets NFPA Code 30 and OSHA Standard 1910.106 for safe storage of flammables. Tough powder coat finish. Ships set up. Color: yellow. *IN STOCK.*



A 7839709-V



B 7839909-S



B 7840009-S

A. Compact Safety Cabinets

Overall WxDxH	Cap. Gal.	Door Qty.	Shelf Qty.	Stock Number	\$
MANUAL-CLOSING DOOR					
23x18x35"	12	1	1	7839709-V	381.00
SELF-CLOSING DOOR					
23x18x36 7/8"	12	1	1	7839809-S	402.00

B. Double-Wall Safety Cabinets

Overall WxDxH	Cap. Gal.	Door Qty.	Shelf Qty.	Stock Number	\$
MANUAL-CLOSING DOORS					
43x18x44"	30	2	1	7839909-S	537.00
43x18x65"	45	2	2	7840009-S	792.00
34x34x65"	60	2	2	7840109-T	1046.00
43x34x65"	90	2	2	7840209-S	1120.00
SELF-CLOSING DOORS					
43x18x45 7/8"	30	2	1	7840309-U	764.00
43x18x66 7/8"	45	2	2	7840409-S	945.00
34x34x66 7/8"	60	2	2	7840509-S	1131.00
43x34x66 7/8"	90	2	2	7840609-S	1218.00

Call for these products and **MORE!**



RELIUS SOLUTIONS Steel Safety Guards



RELIUS SOLUTIONS Safety Guardrails



RELIUS SOLUTIONS Aluminum Walk Ramps



RELIUS SOLUTIONS Steel Bollards with Chain Link Slots



RELIUS SOLUTIONS All-Welded Protective Railing

Ships same day for 1-3 day delivery

Ships 1-5 days



Lift out rails slide in and out of mounting brackets.



Three-Rib Steel Protective Rail Systems

- 11-ga. steel rails; 1/4" thick steel posts
- Unassembled components
- Mounting hardware included

The largest, thickest, and most rigid rail system on the market today. 14"H corrugated steel rails are mounted to 1/4" thick structural steel posts. Secured with 3 bolts per rail end in pre-tapped connection holes. 10" sq., 5/8" thick steel baseplate may be bolted to the floor for added stability. Yellow powder coat finish. *IN STOCK.*

Posts

Description	Overall Ht.	Stock No.	\$
Single-Corner Post	18"	4222400-W	158.00
Single-Line Post	18"	4226900-W	167.00
Double-Corner Post	42"	4227400-W	229.00
Double-Line Post	42"	4227500-W	226.00

Rails

Overall Length	BOLT-ON RAILS		LIFT-OUT RAILS	
	Stock No.	\$	Stock No.	\$
10'	4220801-U	291.00	4220802-U	371.00
8'	4221001-U	252.00	4221002-U	314.00
6'	4221101-U	217.00	4221102-U	278.00
4'	4222301-U	180.00	4222302-U	243.00



Removable rails offer access to machinery for repairs or maintenance.



Impact-Resistant Protective Railing

- 4" square tubular 7-gauge steel construction
- Unassembled components
- Mounting hardware sold separately

Rails bolt in place for strength and can be easily removed when necessary. 11x11", 1/2" thick foot plates with 7/8" mounting holes. Posts should be bolted to the floor for stability. Ships unassembled. *IN STOCK.*

Rails

Description	Stock No.	\$	\$ (6+)
4'L Lift-Out Rail	7519100-T	70.50	67.00
6'L Lift-Out Rail	7519200-T	110.00	105.00
8'L Lift-Out Rail	7519300-T	129.00	123.00

Posts. Specify: (01) end post, (02) flush end post, (03) line post, (04) corner post, (05) 3-way post, (06) 4-way post.

Description	Stock Number	(01), (02)	(03), (04)
		\$	\$
45"H Two-Rail Post	75199-W	234.00	246.00



General-purpose perforated tread is for use indoors.

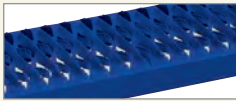

Non-slip Grip Strut tread is ideal for outside or wet areas.



Square tube construction is 40% stronger than round tube; for heavy-duty applications.

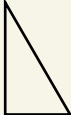

60° standard slope has a shorter base length to fit into small spaces.

5-step and higher unassembled ladders are shipped in protective crating.

Cap. Lbs.





60° Standard Slope Ladders

- Square tube construction
- 60° standard slope
- Perforated or Grip-Strut® tread
- Unassembled
- 350-lb. capacity

Tapered base construction provides greater stability and even wearability of the wheels. Front legs are reinforced using 1/2" pipe. Rubber tipped feet are steel reinforced. Custom-made ladders are available upon request. Oversized top platforms are available in 21" or 28" depths. Durable enamel finish. Made in USA. Specify tread: (03) Perforated, (04) Grip-Strut®.

2- to 5- Step Ladders. Retractable spring-loaded casters. Ship all-welded at no additional freight cost.

Step Qty.**	Top Step Height	Overall Height	18"WX14"D TOP STEP				26"WX14"D TOP STEP				32"WX14"D TOP STEP			
			Overall WxD	Stock Number	(03) \$	(04) \$	Overall WxD	Stock Number	(03) \$	(04) \$	Overall Height	Stock Number	(03) \$	(04) \$
LADDERS WITHOUT HANDRAILS														
2	20"	20"	22x24"	39300-V	173.00	206.00	28x24"	39309-V	183.00	224.00	32x24"	39326-V	211.00	252.00
3	30"	30"	22x28"	39302-V	209.00	245.00	28x28"	39311-V	238.00	261.00	32x28"	39327-V	262.00	316.00
4	40"	40"	22x36"	39304-V	236.00	281.00	30x36"	39313-V	270.00	306.00	32x36"	39333-V	342.00	407.00
LADDERS INCLUDING HANDRAILS														
2	20"	44"	22x24"	39301-V	200.00	241.00	28x24"	39310-V	219.00	257.00	32x24"	39370-V	247.00	294.00
3	30"	54"	22x28"	39303-V	229.00	269.00	28x28"	39312-V	275.00	330.00	32x28"	39328-V	286.00	347.00
4	40"	70"	22x36"	39305-V	333.00	388.00	30x36"	39314-V	332.00	402.00	32x36"	39334-V	399.00	490.00
5	50"	80"	22x43"	39306-V	323.00	349.00	30x44"	39315-V	372.00	399.00	32x43"	39335-V	441.00	527.00

6- to 12-Step Ladders.

Casters release by stepping on the first step. Ship unassembled as all-welded steel components.

Step Qty.**	Top Step Height	Overall Height	18"WX14"D TOP STEP				26"WX14"D TOP STEP				32"WX14"D TOP STEP			
			Overall WxD	Stock Number	(03) \$	(04) \$	Overall WxD	Stock Number	(03) \$	(04) \$	Overall WxD	Stock Number	(03) \$	(04) \$
LADDERS INCLUDING HANDRAILS														
6	60"	93"	22x55"	39307-V	557.00	668.00	30x52"	39316-V	575.00	688.00	32x40"	39336-V	600.00	718.00
7	70"	103"	22x68"	39308-V	600.00	728.00	30x60"	39325-V	617.00	626.00	32x55"	39345-V	651.00	781.00
8	80"	113"	—	—	—	—	32x68"	39346-V	668.00	802.00	34x61"	39355-V	741.00	893.00
9	90"	123"	—	—	—	—	32x76"	39347-V	791.00	873.00	34x67"	39356-V	812.00	971.00
10	100"	133"	—	—	—	—	32x84"	39348-V	798.00	951.00	34x73"	39357-V	916.00	1091.00
11	110"	144"	—	—	—	—	32x92"	39349-V	898.00	1071.00	34x89"	39358-V	996.00	1197.00
12	120"	150"	—	—	—	—	32x100"	39350-V	1089.00	1158.00	34x95"	39359-V	1090.00	1322.00

*Ship via small package carrier.

**Step Qty. includes top platform. 2, 3, & 4 step (without handrails) shipped fully assembled.

Ships same day for 1-3 day delivery

Ships 1-5 days



Scratch-Resistant DuraRib™ Strip Door



Standard Smooth Strip Door

Additional strip door options available, please call.

PVC Strip Profiles:

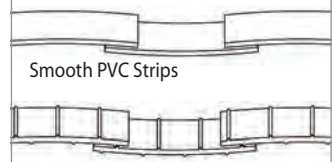

Smooth PVC Strips

DuraRib PVC Strips with ribbed profile to prevent scratches and increase clarity and durability



PVC Strip Types:

Standard PVC is recommended for exterior or interior applications from -10° to 150°F.

Low-temperature PVC is suited for interior applications between -40° and 90°F.

All strips include anti-fungal additive that prevents fungal growth on strips. All strips are USDA and FDA compliant and CFIA approved.

Relius Energy-Saving Strip Door Kits

PVC strip doors reduce energy costs, prevent infiltration of cold or hot air, dust, birds and insects while maintaining a comfortable work environment. Clear, flexible strips overlap to seal the doorway, while allowing personnel and vehicles to move freely through the facility. PVC strips are pre-cut and pre-punched for easy installation. Made in USA. **FACTORY QUICK SHIP.**

Strip Width	Door WxH	Strip Thickness	SMOOTH				SCRATCH-RESISTANT DURARIB				
			STANDARD		LOW-TEMP		Strip Thickness	STANDARD		LOW-TEMP	
			Stock No.	\$	Stock No.	\$		Stock No.	\$	Stock No.	\$
8"	3x7'	.080"	77441-W	103.00	77454-W	123.00	.072"	77467-W	113.00	77480-W	134.00
8"	4x7'	.080"	77442-W	137.00	77455-W	164.00	.072"	77468-W	150.00	77481-W	178.00
8"	4x8'	.080"	77443-W	151.00	77456-W	181.00	.072"	77469-W	166.00	77482-W	196.00
8"	5x8'	.080"	77444-W	189.00	77457-W	227.00	.072"	77470-W	208.00	77483-W	246.00
8"	6x8'	.080"	77445-W	227.00	77458-W	272.00	.072"	77471-W	250.00	77484-W	295.00
8"	8x8'	.080"	77446-W	302.00	77459-W	362.00	.072"	77472-W	332.00	77485-W	392.00
12"	8x8'	.120"	77447-W	371.00	77460-W	446.00	.110"	77473-W	408.00	77486-W	483.00
12"	8x10'	.120"	77448-W	444.00	77461-W	533.00	.110"	77474-W	488.00	77487-W	577.00
12"	9x9'	.120"	77449-W	458.00	77462-W	550.00	.110"	77475-W	504.00	77488-W	596.00
12"	10x10'	.120"	77450-W	556.00	77463-W	667.00	.110"	77476-W	611.00	77489-W	722.00
12"	10x12'	.120"	77451-W	658.00	77464-W	777.00	.110"	77477-W	713.00	77490-W	842.00
12"	11x11'	.120"	77452-W	661.00	77465-W	793.00	.110"	77478-W	727.00	77491-W	860.00
12"	12x12'	.120"	77453-W	777.00	77466-W	793.00	.110"	77479-W	855.00	77492-W	1010.00



DuraRib

Mounting hardware required, call our sales team for details.



Smooth

Relius Flexible Bulk PVC Strip Rolls

Continuous full-length flexible PVC rolls. Made in USA. *Two strip types available: standard PVC is recommended for exterior or interior applications from 0° to 150°F; low-temperature PVC is suited for interior applications between -20° and 40°F. Both are USDA and FDA compliant and CFIA approved. FACTORY QUICK SHIP.*



Roll Length	Strip Thickness	Strip Width	Strip Profile	STANDARD		LOW-TEMP.	
				Stock No.	\$	Stock No.	\$
300'	.060"	4"	Smooth	7751901-W	135.00	7751902-W	207.00
150'	.060"	6"	Smooth	7752001-W	97.70	7752002-W	175.00
300'	.060"	6"	Smooth	7752101-W	171.00	7752102-W	330.00
150'	.080"	8"	Smooth	7752201-W	148.00	7752202-W	214.00
300'	.080"	8"	Smooth	7752301-W	278.00	7752302-W	306.00
75'	.120"	12"	Smooth	7752401-W	193.00	7752402-W	477.00
150'	.120"	12"	Smooth	7752501-W	326.00	7752502-W	464.00
100'	.160"	16"	Smooth	7752601-W	426.00	7752602-W	442.00
60'	.080"	48"	Smooth	7752701-W	422.00	7752702-W	176.00
60'	.120"	48"	Smooth	7752801-W	632.00	7752802-W	412.00
150'	.072"	8"	Scratch-resistant DuraRib	7752901-W	163.00	7752902-W	182.00
150'	.110"	12"	Scratch-resistant DuraRib	7753001-W	382.00	7753002-W	427.00



Convex Safety Mirrors

Wide-angle mirrors provide a full 160° view for walkways, aisles, and other high-traffic areas. Reduces collisions and improves safety. All mirrors include an easily installable swivel mounting bracket that allows mirror to be positioned to any angle needed. Mirrors are not recommended for high-wind areas. Made in Canada. *IN STOCK.*

Acrylic

Unbreakable acrylic mirrors are distortion-free and are 20% brighter than glass. All acrylic mirrors have injection molded plastic backs for strength and durability.

Overall Dia.	INDOOR		OUTDOOR	
	Stock No.	\$	Stock No.	\$
12"	7950501-V	23.00	7950502-V	27.00
18"	7940601-V	33.00	7940602-V	43.00
26"	7940701-V	60.00	7940702-V	70.00
30"	7940801-V	81.00	7940802-V	98.00
36"	7940901-V	103.00	7940902-V	121.00
48"	7941001-V*	181.00	7941002-V*	239.00

*48" mirrors have hardboard backs and two sets of mounting hardware.

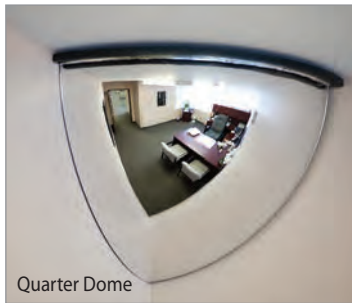

Quarter Dome



Half Dome



Full Dome



Panoramic Dome Mirrors

Provide the best overhead view. Reduces accidents and increases safety. Designed for indoor use. 18–36" dia. mirrors have plastic molded back, 48" mirrors have hardboard back. Includes D-clip for simple installation. Made in Canada. *SELECTED MODELS IN STOCK.*



Quarter Dome

Acrylic. Provides 90° view.

Overall Dia.	Stock No.	\$
18"	7942000-V	17.90
26"	7942100-V	25.40
32"	7942200-V	36.00
36"	7942300-V	36.60
48"	7942400-V	70.90



Quarter Dome
90° viewing area

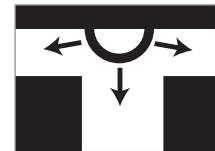

Half Dome
180° viewing area

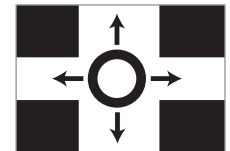

Full Dome
360° viewing area

Half Dome

Acrylic or scratch-resistant acrylic. Provides 180° view.

Overall Dia.	ACRYLIC		SCRATCH-RESISTANT ACRYLIC	
	Stock No.	\$	Stock No.	\$
18"	7942501-V	28.00	7942502-V	57.00
26"	7942601-V	44.00	7942602-V	85.00
32"	7942701-V	64.00	7942702-V	116.00
36"	7942801-V	74.00	7942802-V	126.00
48"	7942901-V	158.00	7942902-V	198.00

Full Dome

Acrylic or scratch-resistant acrylic. Provides 360° view.

Overall Dia.	ACRYLIC		SCRATCH-RESISTANT ACRYLIC	
	Stock No.	\$	Stock No.	\$
18"	7943001-V	41.00	7943002-V	110.00
26"	7943101-V	71.00	7943102-V	160.00
32"	7943201-V	95.00	7943202-V	239.00
36"	7943301-V	110.00	7943302-V	246.00
48"	7943401-V	234.00	7943402-V	460.00

Ships same day for
1–3 day delivery

Ships 1–5 days



Relius
solutions **Shop Desks**

Locking drawers and handy compartments store packing slips, invoices, tape, pens, etc. Made in USA. *IN STOCK.*

A. Foreman's Desk

- 20-gauge steel work surface; 22-gauge steel body
- 14-gauge steel legs
- Unassembled
- Cylinder locking drawer

Three-compartment sorter and full-length 22-gauge steel riser with sloped writing top. Large 24x28x3 1/2" H drawer. Powder coat finish.

B. Deluxe Pedestal Desk

- 20-gauge steel work surface; 20-gauge steel body
- 16-gauge steel legs
- Unassembled
- Cylinder locking drawer

Eight-compartment 22-gauge steel riser. Includes two double-deep file drawers, an all-purpose drawer, and a tray drawer. Lower shelf/footrest. Powder coat finish.

Key	Overall WxDxH	Drawer Qty.	Enclosed Cabinet	Stock Number	\$
A	34 1/2"x30x53"	1	No	5301200-S	193.00
B	39x28 1/2"x55 1/2"	4	No	5267100-S	597.00



Relius
solutions **Mobile Computer Cabinets**

- 20-gauge steel door; 19-gauge steel body
 - Unassembled
 - Locking lower cabinet and monitor hood
- IN STOCK.*

C. & D. Computer Cabinets

Computer stand features: 42"H slide-out keyboard/mouse tray, fixed open shelf, lower cabinet with one adjustable shelf and enclosed back, upper shelf with back and end stops, and 5" hard rubber casters—2 rigid, 2 swivel with brakes. 12" opening between keyboard tray and fixed open shelf. Computer cabinet is available with or without monitor hood. Powder coat finish. *IN STOCK.*

E. Enclosed Monitor Hood

Monitor hood accommodates a 20" flat screen monitor. Includes 26 3/4"Wx8 3/4"Dx19"H locking cabinet with clear Lexan window, piano hinge on door, rear ventilation louvers, and grommet holes for cord management. Comes completely assembled and can be retrofitted to existing computer stand (template provided and drilling required when retrofitting to models purchased prior to 2013). Powder coat finish.

Key	Description	Overall WxDxH	BLUE	GRAY	\$
			Stock No.	Stock No.	
C	Computer cabinet with hood	27x24x70 1/4"	6085518-V	6085527-V	353.00
D	Computer cabinet without hood	27x24x49 1/4"	6085618-V	6085627-V	289.00
E	Retrofit enclosed monitor hood	26 3/4"x9 1/2"x22 1/2"	6085718-V	6085727-V	70.00



ELITE

Stand-Up Mobile Workstation

- Laminate surfaces with steel frame
- Unassembled

Provides a comfortable place for employees to work in industrial settings. Durable workstation features a heavy-gauge steel frame with laminate worksurfaces. Both worksurfaces adjust up or down in 1" increments for maximum flexibility. Upper: 39.4"Wx14"Dx34.1-46.1"H; lower: 39.4"Wx16"Dx28.5-40.5"H. Heavy-duty 4" locking casters move easily across any warehouse surface. Also includes power strip with 3 outlets and cord. *IN STOCK.*

Overall WxDxH	Stock No.	\$
39 1/2"x29x34-46"	2837700-U	237.00





Hardboard Over Steel Top



ITEMS



Steel Top

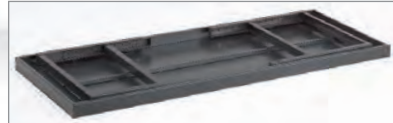

Legs fold into top for easy storage.

Top WxD	Bench Height	13-GA. STEEL TOP		HARDBOARD OVER STEEL TOP	
		Stock No.	\$	Stock No.	\$
84x28"	28-42"	6474800-W	285.00	5403400-V	611.00
84x34"	28-42"	6474900-W	319.00	5403500-V	737.00
84x48"	28-42"	6475000-W	385.00	5406100-V	966.00
96x28"	28-42"	6475100-W	305.00	5403600-V	701.00
96x34"	28-42"	6475200-W	349.00	5403700-V	813.00
96x48"	28-42"	6475300-W	420.00	5408800-V	1075.00
120x28"	28-42"	6475400-W*	399.00	5403800-V*	857.00
120x34"	28-42"	6475500-W*	445.00	5403900-V*	980.00
120x48"	28-42"	6475600-W*	579.00	5415800-V*	1111.00

Relius solutions Folding Worktables

- 14-gauge steel legs
- 13-gauge steel or hardboard over 13-gauge steel top
- 84-120" wide tops
- Unassembled

Legs fold down for convenient bench storage. Thick formed tops have welded channels underneath. 2000-lb. capacity. Includes two brace supports and hardware. Color: gray. **SELECTED MODELS IN STOCK.**

*Table comes with 3 legs.



1 1/2" Thick Butcher Block Maple Top Workbenches

- 16-gauge steel legs; 14-gauge steel stringer
- Square edge or comfort edge maple top
- 60" and 72" wide tops
- Unassembled

Warp-resistant and electronically Thermobonded for toughness. Laminated clear through. Penetrating oil finish comprised of pure mineral oil, raw linseed oil, and melted paraffin seals out liquids. Can be sanded down. Periodic applications of NSF-approved penetrating oil will help preserve top's original composition. Made in USA. **IN STOCK.**

NSF-approved penetrating oil is available—please call.



1 1/2" Thick Laminated Square-Edge Maple Top



1 1/2" Thick Laminated "Comfort" Edge Maple Top

Top WxD	FIXED-HEIGHT LEGS			ADJUSTABLE-HEIGHT LEGS		
	Bench Ht.	Stock No.	\$	Bench Ht.	Stock No.	\$
SQUARE-EDGE TOP						
60x30"	33 1/2"	5520401-S	255.00	30 1/2-34 1/2"	5520402-S	262.00
72x30"	33 1/2"	5520501-S	291.00	30 1/2-34 1/2"	5520502-S	299.70
72x36"	33 1/2"	5520601-S	338.00	30 1/2-34 1/2"	5520602-S	325.00
"COMFORT" EDGE TOP						
60x30"	33 1/2"	5599701-S	279.00	30 1/2-34 1/2"	5599702-S	267.00
72x30"	33 1/2"	5599801-S	315.00	30 1/2-34 1/2"	5599802-S	311.00
72x36"	33 1/2"	5599901-S	358.00	30 1/2-34 1/2"	5599902-S	354.00

Call for these products and **MORE!**



RELIUS SOLUTIONS Adjustable-Height Shop Stools



RELIUS SOLUTIONS Industrial Seating



RELIUS SOLUTIONS Polyurethane Stools



RELIUS SOLUTIONS Continuous-Use Seating



RELIUS SOLUTIONS Vinyl Task Seating

Ships same day for 1-3 day delivery

Ships 1-5 days

Relius Vertical Filing Systems. *IN STOCK.*

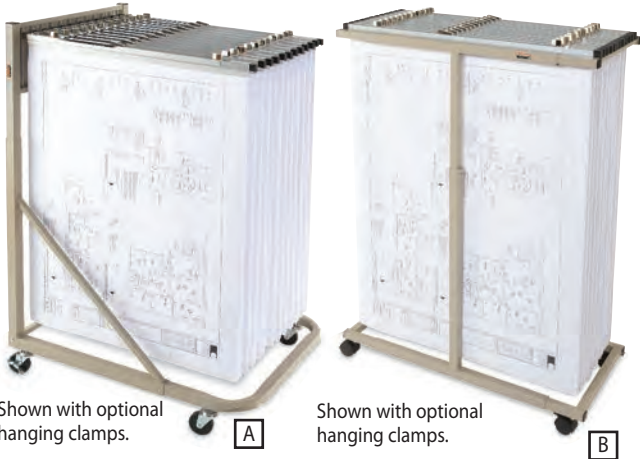

A. Mobile Rack

Heavy-gauge steel telescoping channel adjusts in height and depth. Includes 12 chrome-plated pivot brackets and (4) 3" swivel casters (rear casters lock). Holds 18" to 42"L hanging clamps (sold separately) and sheets to 60" long. Accepts 12 hanging clamps that each hold up to 100 sheets; 1200 sheet maximum. Powder coat finish. Color: sand. Unassembled.

Overall WxDxH	Stock No.	\$
28-43x27x45-60"	1920200-T	390.00

B. Mobile Plan Center

Stores large sheets up to 50". Telescoping channel adjusts in height and depth. Accepts (12) 24", 30", or 36" long hanging clamps (sold separately). Clamps lift out and drop in for easy access to materials. Heavy-gauge steel channel construction. Four swivel casters (two locking). Powder coat finish. Color: sand. Unassembled.

Overall WxDxH	Stock No.	\$
26-38x16x39-53"	1920100-T	222.00

C. Drop Lift Wall Rack

Lift-out and drop-in clamps offer easy access to blueprints. Entire unit extends only 15" from the wall. Accepts up to 1200 sheets. Holds (12) hanging clamps from 18-42"L (sold separately). Powder coat finish. Color: sand.

Overall WxDxH	Stock No.	\$
18-42x15x8"	1920400-T	41.10



D. Pivot Wall Rack

Stud-spaced mounting holes permit secure fastening to the wall. Includes (12) chrome-plated pivot brackets. Accepts (12) 18-42" long hanging clamps (sold separately). Holds up to 1200 sheets. Powder coat finish. Color: sand.

Overall WxDxH	Stock No.	\$
23x14x10"	1920300-T	167.00

Hanging Clamps

File up to 100 sheets. Extruded anodized aluminum clamp, internal steel spring, and chrome-plated steel wing knob. Includes snap-on clear plastic label holder. Sold in packs of 6, priced per pack.

Overall Lgth.	Pkg. Qty.	Stock No.	\$ Pkg.
18"	6	1920501-T	95.90
24"	6	1920502-T	112.00
30"	6	1920503-T	122.00
36"	6	1920504-T	147.00
42"	6	1920505-T	163.00

SAFCO® Vertical File Systems available, call for information.

SAME-DAY SHIPPING on in-stock products!

Relius Aluminum Frame Cork Boards

• *Cork board* • *Anodized aluminum frame*
Choose between indoor or outdoor boards to best fit your needs. Shatter-resistant acrylic window offers clear visibility of posted material. Lockable doors have full-length piano-style hinges. Two keys included. Interior is 3/8" deep. Made in USA. **SELECTED MODELS IN STOCK AND FACTORY QUICK SHIP.**

Door Qty.	Overall WxH	INDOOR		OUTDOOR	
		Stock No.	\$	Stock No.	\$
1	18x24"	3453001-T	175.00	3453002-T	207.00
1	24x36"	3453101-T	236.00	3453102-T	264.00
1	36x36"	3453201-T	282.00	3453202-T	308.00
2	48x36"	3453301-T	364.00	3453302-T	381.00
2	60x36"	3453401-T	429.00	3453402-T	467.00
3	72x36"	3453501-T	537.00	3453502-T	587.00
3	72x48"	3453601-T	683.00	3453602-T	719.00
3	96x48"	3453701-T	844.00	3453702-T	880.00





Smart Diamond-Plate Mats

- For use in dry work areas
- 33% post-industrial recycled PVC top with 100% post-consumer recycled urethane composite sponge base
- 5/8" or 1" thick

Economical mat helps you go green. Earth-friendly mat is made of 80% post industrial/post consumer materials. Features a slip-resistant, diamond-embossed surface and beveled safety borders. Made in USA. **SELECTED MODELS IN STOCK.**



Size	Thickness	BLACK		BLACK/YELLOW BORDER	
		Stock No.	\$	Stock No.	\$
2x3'	5/8"	6036629-T	27.60	6036609-T	30.40
3x5'	5/8"	6036729-T	59.90	6036709-T	60.70
3x75'	5/8"	6037229-T	855.00	6037209-T	868.00
2x3'	1"	6037629-T	37.90	6037609-T	40.10
3x5'	1"	6037729-T	87.90	6037709-T	88.70
3x75'	1"	6037929-T	1276.00	6037909-T	1132.00



Bubble-Top Anti-Fatigue Mats

- Suitable for dry work areas with multi-shift operations
- Heavy-duty vinyl top over dense sponge base
- 1/2" and 1" thicknesses

Bubble-top surface cushions and protects users' feet. Resists wear and tear. Beveled edges and non-slip backing provide additional safety. Bond of top and base layers guaranteed for the life of the mat. Made in USA. **Specify border color: (09) yellow, (27) gray, (29) black.**



Size	Stock Number	(09), (27)	(29)
		\$	\$
1/2" THICK			
2x3'	60863-S	58.90	55.30
3x5'	60864-T	148.00	139.00
1" THICK			
2x3'	60865-T	70.70	66.30
3x5'	60866-S	177.00	166.00

Size	BLACK/YELLOW BORDER	GRAY	BLACK	\$
	Stock No.	Stock No.	Stock No.	
3/8" PRE-CUT MATS				
2x3'	3376209-S	3376227-S	3376229-S	9.30
3x5'	4376409-S	4376427-S	4376429-S	41.00
3x12'	4376309-S	4376327-S	4376329-S	98.20
3/8" 60' ROLLS				
3'W	4385809-S	4385827-S	4385829-S	443.00
4'W	4385909-S	4385927-S	4385929-S	582.00
3/8" CUSTOM CUT*. Specify length up to 60'—priced/ft.				
3'W	4386809-S	4386827-S	4386829-S	8.40
4'W	4386909-S	4386927-S	4386929-S	12.10
5/8" PRE-CUT MATS				
2x3'	—	4344627-S	4344629-S	24.40
3x5'	—	4344727-S	4344729-S	61.00
5/8" CUSTOM CUT*. Specify length up to 60'—priced/ft.				
2'W	—	4343827-S	4343829-S	9.30
3'W	—	4343927-S	4343929-S	13.40
4'W	—	4344027-S	4344029-S	17.90

*No returns on custom-cut mats.

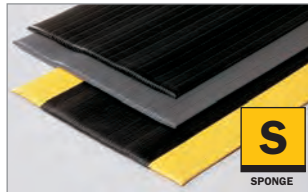

Anti-Fatigue Vinyl Mats

- Designed for any dry work area
- Closed cell vinyl sponge construction
- 3/8" or 5/8" thick

Will not stick to or stain floors. Non-porous surface and base. Beveled safety edges. Not for use with animal fats such as lard or renderings. **SELECTED MODELS IN STOCK.**



Waffle-Base Anti-Fatigue Mats

- Perfect for use around chemicals and in wet or dry work areas
- Rubber construction
- 1/2" or 3/4" thick

Resilient waffle base with skid-resistant surface. Flame-resistant. Color: black. Made in USA. **IN STOCK.**

Size	Description	Stock No.	\$
3/4" THICK			
24x72"	Beveled on 3 sides	4325000-T	53.70
36x48"	Beveled on 3 sides	4325100-T	53.70
48x72"	Beveled on 4 sides	4325200-T	99.90
1/2" THICK			
24x72"	Beveled on 3 sides	4381400-T	42.80
36x48"	Beveled on 3 sides	4381500-T	42.80
48x72"	Beveled on 4 sides	4381600-T	81.10



Ships same day for 1-3 day delivery

Ships 1-5 days



Relius
solutions

Adjustable Work Positioner

- 330-lb. capacity
- Platform size: 20"Wx16"D
- Two platform heights available
- Platform tilt: 0-40°

To adjust height, release fixing bolt, pull toggle upwards, adjust height, and retighten bolt. 12-gauge steel construction. Platform has 1" ledge. Four 3" swivel polyurethane casters with brake. *IN STOCK.*

Platform Height	Stock Number	\$
20-27 1/2"	7025501-U	329.00
28 1/4-42"	7025502-U	348.00



Heat-Treated and Stamped Pallet



96x40" pallet is perfect for storing pallet rack beams, uprights, or other long materials.

Relius
solutions

Hardwood Pallets

- Maple, oak, and birch (non-coniferous) hardwoods
- Stackable

Computerized nailing system promotes uniform durability. 9/16" thick planks are supported by three 48"Lx3 5/8"H, 1 1/4" thick stringers. Notched for 4-way fork entry. Meets GMA standard. Order in quantities of 10, priced each. Made in USA. *IN STOCK.*

Overall WxLxH	Floor Cap. Lbs.	Fork Cap. Lbs.	Stock Number	\$ (10+)	\$ (50+)	\$ (100+)
STANDARD PALLET						
48x40x4 7/8"	4180	2090	4428700-S	18.90	18.00	17.10
48x48x4 7/8"	3718	1582	7695000-S	27.20	—	—
72x40x4 7/8"	3644	—	7695100-S	22.60	21.50	20.50
96x40x4 7/8"	4453	—	7695200-S	27.50	26.20	24.90
Heat-treated and stamped pallet. Meets ISPM 15 specifications.						
48x40x4 7/8"	5000	2500	4443300-S	22.30	21.20	20.20
64x48x4 7/8"	2895	—	7698300-S	33.10	31.50	30.00
80x48x4 7/8"	3463	—	7698900-S	41.60	39.60	37.70



7133401-S steel-bound wood deck

7133702-S 13-gauge steel treadplate deck

Relius
solutions

High-End Platform Trucks

- 1800-lb. capacity
- Two deck materials available
- 11" and 12" deck heights

Choose from two deck types to meet your material handling needs. Two removable 51"H handles. Two rigid 8" polyurethane wheels and four swivel 4" hard rubber casters allow truck to turn on its own radius. *IN STOCK.*

Deck LxW	STEEL-BOUND WOOD DECK			13-GAUGE STEEL TREADPLATE DECK		
	Deck Height	Stock Number	\$	Deck Height	Stock Number	\$
48x16"	12"	7133401-S	235.00	11"	7133402-V	249.00
60x16"	12"	7133501-S	247.00	11"	7133502-V	264.00
60x24"*	12"	7133701-V	282.00	11"	7133702-S	308.00

*24"W trucks have (2) middle vertical bars in handles.



Steel cover easily flips open, and protects LCD display when not in use.



JET Pallet Trucks are available, call for information.

HERCULES

Premium Scale Pallet Truck

- 4400-lb. capacity
- 3.3" lowered height

Reliable scale features keyboard calibration and functional set-up with automatic zero capabilities. Fingertip lever controls raise, lower and neutral operations. Weighs in pounds or kilograms. Large LCD display uses standard AA battery pack of 4, no charger needed. Polyurethane wheels—(2) 7" steering and (2) 2.7" load wheels. *IN STOCK.*

Weighing Increment	Fork Height, Raised	Fork Width, Overall	Fork Length, Overall	Stock Number	\$
1 lb./0.5 kg	8"	22"	46"	5797404-T	2075.00
1 lb./0.5 kg	8"	27 1/2"	46"	5797408-T	2100.00



5500-Lb. Capacity Pallet Trucks

• 5-year warranty

Economical pallet truck does all the work of the higher-priced models. Spring-loaded handle has 3-position raise, lower, neutral fingertip control. Green powder coat finish with gray handle and pump. *IN STOCK.*

Fork Width, Overall	Fork Length, Overall	Stock Number	\$
20.5"	48"	6091504-S	301.00
27"	48"	6091508-S	317.00

For complete specifications, see chart at bottom of page.



5500-Lb. Capacity Pallet Truck

• 5-year warranty

Virtually maintenance free. Spring-loaded handle has 3-position raise, lower, neutral fingertip control. Blue powder coat finish. *IN STOCK.*

Fork Width, Overall	Fork Length, Overall	Stock Number	\$
21"	48"	7974004-V	385.00
27"	48"	7974008-V	393.00

For complete specifications, see chart at bottom of page.



Quick Lift cast steel pump raises 0-330 lb. loads off the floor with only 2 strokes



Premium 6600-Lb. Capacity Pallet Truck

• 5-year warranty

Built to last with extra-thick steel and reinforced fork bracing. Reinforced spring-loaded ergonomic handle includes rubber covered top and 3-position raise, lower, and neutral fingertip controls. Extra-large bearing under apron head for smoother maneuverability. Specially designed cast steel pump. Orange powder coat finish. *IN STOCK.*

Fork Width, Overall	Fork Length, Overall	Stock Number	\$
21"	48"	7873304-V	459.00
27"	48"	7873308-V	479.00

For complete specifications, see chart at bottom of page.

Specially designed cast steel pump.



Pallet Truck Specifications

Stock Number	Cap. Lbs.	Fork Height, Lowered	Fork Height, Raised	Fork Width, Individual	Steering Arc	Steer Wheels Description	Load Rollers Description	Fork Entry Wheel Material
6091504-S	5500	2.9"	7 1/2"	6.3"	200°	7" Polyurethane	2.9" Polyurethane	Nylon
6091508-S	5500	2.9"	7 1/2"	6.3"	200°	7" Polyurethane	2.9" Polyurethane	Nylon
7974004-V	5500	2.9"	7 1/2"	6.3"	205°	7" Polyurethane	2.9" Polyurethane	Nylon
7974008-V	5500	2.9"	7 1/2"	6.3"	205°	7" Polyurethane	2.9" Polyurethane	Nylon
7873304-V	6600	2.9"	7 1/2"	6.3"	205°	7" Polyurethane	2.9" Polyurethane	Polyurethane
7873308-V	6600	2.9"	7 1/2"	6.3"	205°	7" Polyurethane	2.9" Polyurethane	Polyurethane

Ships same day for 1-3 day delivery

Ships 1-5 days



Pallet positioner lowered to floor.

Battery powered unit in raised position.



Pallet positioner lowered to floor.



LIFTS OPEN OR CLOSED PALLETS.
NOTE: SET CLOSED PALLETS ON TOP OF FORKS.



Manual unit in raised position.



High Lift Pallet Positioner

- 3300-lb. capacity
- Multiple lift heights
- Manual and powered lift models available

Manual hand pump model requires 28 strokes without load and 62 strokes with load to reach maximum working height. 12-volt, DC battery-powered model has an 11-second lift time without load and a 19-second lift time with load. Includes battery and remote charger. Both feature 180° steering arc and polyurethane swivel and load rollers. *IN STOCK.*

12-Volt, DC Battery-Powered Model

Cap. Lbs.	Lift Height	Fork Carriage Overall WxL	Stock Number	\$
3300	3.3-31"	21x44 1/2"	7172901-S	2821.00
3300	3.3-31"	27x44 1/2"	7172902-S	2788.00

Manual Hand Pump Model

Cap. Lbs.	Lift Height	Fork Carriage Overall WxL	Stock Number	\$
3300	3.6-31.5"	21x44 1/2"	7107401-S	797.00
3300	3.6-31.5"	27x44 1/2"	7107402-S	847.00



Mechanical Mobile Scissor Lift Table

- Up to 1100-lb. capacity
- Manual hand crank
- Hand crank lift

Steel construction with 5" polyurethane casters—2 rigid, 2 swivel with brakes. Color: yellow. *IN STOCK.*

Cap. Lbs.	Lift Height	Platform WxD	Overall WxD	Stock Number	\$
660	17-39"	37x24"	40x24"	7143200-U	525.00
1100	21.7-39.4"	39.4x25.6"	46.5x25.6"	5703000-T	563.00



Steel Pallet Conveyors

2" dia.x49 1/2"W, 12-ga. spring loaded rollers run on 3" centers. Rollers are set low on 7/16" hex axles. 50" wide between rails. All-welded, 3 1/2"x1", 1" thick 10-ga. channel steel frame with butt couplers. 300-lb. capacity per roller. 3500-lb. fully supported frame capacity on the floor. If H-stands are needed, 5' centers are mandatory (call for information). Ships unassembled. Made in USA.

Width	Overall Lgth.	Stock Number	\$
52"	10'	7603500-T	1026.00
52"	5'	7603600-T	577.00

Collapsible container with powder coat finish is available, please call.



3527501-V shown with optional casters.



3527401-V



Shown: 3527602-V container with lid.



Collapsible Wire Containers

- Steel wire
- 4-way fork access
- Stackable

High-strength, lightweight containers add less weight to shipping costs. Welded, square mesh wire. Include half-drop side gates and caster pads. 4" underclearance. **IN STOCK.**

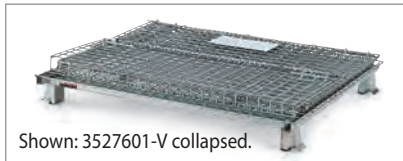

Shown: 3527601-V collapsed.

Collapsible Wire Containers with Zinc-Plated Finish

Optional casters sold separately. *Specify: (01) container only, (02) container with lid. IN STOCK.*

Overall WxLxH	Cap. Lbs.	Cap. Cu. Ft.	Inside Height	Collapsed Height	Drop Gate Side	Mesh Size	Mesh Gauge	CONTAINER		CONTAINER WITH LID	
								Stock Number	\$	Stock Number	\$
32x20x21"	1500	5.2	15.88"	6 1/2"	32"	1 7/8x1"	5	3527301-V	96.90	—	—
32x20x21"	1500	5.2	15.88"	6 1/2"	32"	1x1"	5	3527401-V	116.00	—	—
40x32x33 1/2"	4000	19.8	28.19"	8 1/4"	40"	2"	3	3527501-V	178.00	3527502-V	207.00
48x40x35"	4000	30.8	29.78"	8 1/4"	48"	2"	3	3527601-V	239.00	3527602-V	278.00
48x40x39 1/2"	4000	38.3	34.14"	8 1/4"	48"	2"	3	3527701-V	255.00	3527702-V	299.00

3527800-V Optional 4x2" phenolic casters. \$.....69.60

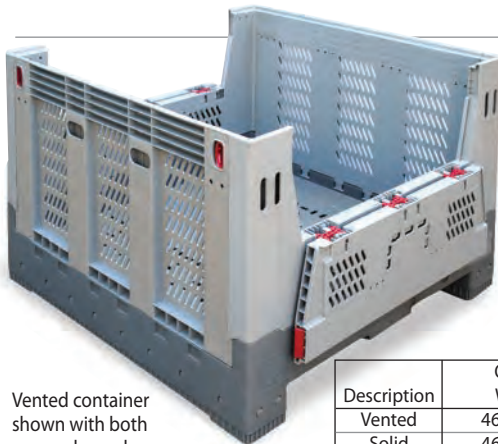

Vented container shown with both access doors down.



Collapsible Bulk Containers

- Injection molded HDPE
- Recyclable
- 2-way fork access
- Stackable



Containers fold flat for storage. When filled, containers stack up to 3 high, with a capacity of 1000 lbs. each. When used for stationary, non-stacked storage, capacity reaches 6000 lbs. Resistant to extreme temperatures. Rugged, easy to clean. 33 3/4"Wx33 1/4"H fork openings.

Description	Overall WxLxH	Cap. Lbs.	Cap. Cu. Ft.	Inside Height	Collapsed Height	Access Door Side	Stock Number	\$
Vented	46x46x31"	2000	26	25"	11"	On 46" sides	7858800-T	438.00
Solid	46x46x31"	2000	26	25"	11"	On 46" sides	7858700-T	438.00

Call for these products and **MORE!**



RELIUS SOLUTIONS Roller Track Conveyors



RELIUS SOLUTIONS Roller Conveyors



RELIUS SOLUTIONS Ball Transfer Table



RELIUS SOLUTIONS H-Stands



RELIUS SOLUTIONS Skate Wheel Conveyors

Ships same day for 1-3 day delivery

Ships 1-5 days



Also available in:

(27) gray

(29) black

(30) natural

Relius solutions Hopper Front Bulk Truck

- Polyethylene
- 6" rubber casters

Heavy-duty polyethylene material is UV-protected. Hopper front eases loading and unloading of materials. Heavy-duty enamel-coated steel base. Hand grips on each side help guide unit. Rolls on 2 rigid and 2 swivel casters. Made in USA. *Specify color: (19) blue, (27) gray, (29) black, (30) natural.*

Overall WxDxH	Cap. Lbs.	Cap. Cu. Ft.	Cap. Bu.	Inside Height	Stock Number	\$
28x48x66 1/2"	800	48	38	58"	66690-T	442.00
30x60x70"	1000	62	49	59"	66691-T	525.00



Relius solutions Economical Heavy-Duty Poly Trucks

- .225-.250" thick polyethylene
- 3" rubber or 5" polyurethane casters

Body features molded vertical side ribs. Angle iron base frame bolted through body offers superior strength and support. Two rigid and two swivel casters are welded to frame at the corners. Made in USA. *Specify color: (02) red, (09) yellow, (18) blue, (27) gray, (30) white. FACTORY QUICK SHIP.*

Also available in:

(02) red

(09) yellow

(18) blue

(30) white

Overall WxDxH	Cap. Lbs.	Cap. Cu. Ft.	Cap. Bu.	Inside Height	Caster Height	Caster Type	Stock Number	\$	Stock Number	\$
POLY TRUCKS										
23 1/2 x 32 1/2 x 24"	400	5.6	6	20"	3"	Rubber	48062-V	229.00	48068-V	56.20
24 1/2 x 36 1/2 x 27"	400	8	8	23"	3"	Rubber	48063-V	262.00	48080-V	66.30
29 1/2 x 38 1/2 x 31"	600	9.25	10	24 1/2"	5"	Polyurethane	48064-V	280.00	34600-V	76.00
28 1/2 x 38 x 34 1/4"	600	11.2	12	27 3/4"	5"	Polyurethane	48065-V	295.00	34601-V	78.80
31 1/2 x 43 3/4 x 35"	600	15.3	14	28 1/2"	5"	Polyurethane	48066-V	314.00	34602-V	87.00
31 x 45 x 36"	800	15.8	16	29 1/2"	5"	Polyurethane	48067-V	324.00	34603-V	90.20
34 x 46 1/2 x 37 3/4"	800	20.5	18	31"	5"	Polyurethane	48108-V	346.00	34604-V	98.50
34 x 46 x 39"	800	21.8	20	32 1/2"	5"	Polyurethane	48109-V	369.00	34605-V	105.00
LIDS										

RUBBERMAID Cube Trucks available, call for information.



16-bu. standard vinyl basket truck shown in (02) red.



6-Bu. Standard Canvas Basket Truck

Choose from 6 Vinyl Colors:

(02) red

(09) yellow

(11) green

(18) blue

(28) gray

(29) black

Relius solutions Basket Trucks by ROYAL

- Canvas and vinyl liners available
- Polyurethane casters

Available in canvas or vinyl that resists tears, punctures and abrasions—impervious to most contaminants, resists ultraviolet degradation and mildew growth. Seam-welded steel frame, hardwood base. Both liners are sewn and riveted for extra strength and have a black vinyl top rim, vinyl reinforced wear points, reinforced handles on both ends, and extra-large work order pocket. Four swivel non-marking casters. Made in USA. *For vinyl trucks, specify color: (02) red, (09) yellow, (11) green, (18) blue, (28) gray, (29) black. SELECTED MODELS IN STOCK. Others FACTORY QUICK SHIP.*

Overall WxDxH	Cap. Cu. Ft.	Cap. Bu.	Inside Height	BASKET TRUCKS WITH COTTON CANVAS LINERS		BASKET TRUCKS WITH VINYL LINERS	
				Stock No.	\$	Stock No.	\$
20x30x27"	7.1	6	20 1/2"	48343-S	195.00	48316-S*	183.00
22x34x29 1/2"	10.0	8	23"	48344-S	215.00	48317-S	207.00
24x36x31 1/2"	12.5	10	25"	48345-S	232.00	48318-S	229.00
26x36x34"	14.9	12	27 1/2"	48346-S	254.00	48319-S*	223.00
28x40x36 1/2"	19.4	16	30"	48348-S	312.00	48321-S	301.00
30x42x36 1/2"	21.9	18	30"	48349-S	339.00	48322-S	330.00
32x48x36 1/2"	26.7	20	30"	48350-S	361.00	48323-S*	335.00



Standard frame and base.

Heavy-duty basket trucks and spring lifts for trucks available, please call.

*(18) IN STOCK.



6" polyolefin casters 8" mold-on rubber casters



Shown with 8" solid rubber casters.



Shown with 8" polyurethane casters.



Steel Platform Trucks

- 1800–3600-lb. capacities
- 12-gauge steel deck
- Multiple deck heights available

All-welded for long-lasting performance. Base is formed on all sides with channel stiffeners welded underneath. Includes front corner bumpers to protect your walls from damage. 36"H, 1" dia. removable handle. Two swivel, 2 rigid bolted casters. Durable powder coat finish. Unassembled, just add casters. **IN STOCK.**

Deck LxW	6" POLYOLEFIN CASTERS				8" MOLD-ON RUBBER CASTERS				8" SOLID RUBBER CASTERS				8" POLYURETHANE CASTERS			
	Deck Ht.	Cap. Lbs.	Stock Number	\$	Deck Ht.	Cap. Lbs.	Stock Number	\$	Deck Ht.	Cap. Lbs.	Stock Number	\$	Deck Ht.	Cap. Lbs.	Stock Number	\$
COLOR: BLUE																
36x24"	9 1/2"	3000	5896001-U	235.00	11 1/2"	2000	5896002-U	252.00	11 1/2"	1800	5896003-U	318.00	11 1/2"	3600	5896004-U	285.00
48x24"	9 1/2"	3000	5896101-U	258.00	11 1/2"	2000	5896102-U	276.00	11 1/2"	1800	5896103-U	342.00	11 1/2"	3600	5896104-U	308.00
48x30"	9 1/2"	3000	5896201-U	286.00	11 1/2"	2000	5896202-U	304.00	11 1/2"	1800	5896203-U	369.00	11 1/2"	3600	5896204-U	337.00
60x30"	9 1/2"	3000	5896301-U	324.00	11 1/2"	2000	5896302-U	343.00	11 1/2"	1800	5896303-U	408.00	11 1/2"	3600	5896304-U	375.00
72x36"	9 1/2"	3000	5896401-U	395.00	11 1/2"	2000	5896402-U	413.00	11 1/2"	1800	5896403-U	478.00	11 1/2"	3600	5896404-U	445.00
COLOR: GRAY																
36x24"	9 1/2"	3000	5896501-U	235.00	11 1/2"	2000	5896502-U	252.00	11 1/2"	1800	5896503-U	318.00	11 1/2"	3600	5896504-U	285.00
48x24"	9 1/2"	3000	5896601-U	258.00	11 1/2"	2000	5896602-U	276.00	11 1/2"	1800	5896603-U	342.00	11 1/2"	3600	5896604-U	308.00
48x30"	9 1/2"	3000	5896701-U	286.00	11 1/2"	2000	5896702-U	304.00	11 1/2"	1800	5896703-U	369.00	11 1/2"	3600	5896704-U	337.00
60x30"	9 1/2"	3000	5896801-U	324.00	11 1/2"	2000	5896802-U	343.00	11 1/2"	1800	5896803-U	408.00	11 1/2"	3600	5896804-U	375.00
72x36"	9 1/2"	3000	5896901-U	395.00	11 1/2"	2000	5896902-U	413.00	11 1/2"	1800	5896903-U	478.00	11 1/2"	3600	5896904-U	445.00

Choose from 3 caster types



- A. 5" polyurethane
- B. 8" black mold-on rubber
- C. 8" gray non-marking rubber



Also available in:



Deck with wood insert, shown with 5" polyurethane casters.

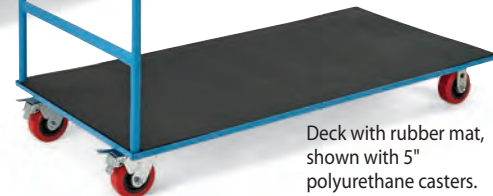

Deck with rubber mat, shown with 5" polyurethane casters.



Premium Wood- or Rubber-Deck Platform Trucks

- 2000-lb. capacity
- Premium wood or rubber decks
- Multiple deck heights available

Seamless, 3/4" thick layered deck has a rattle-free all-welded 12-gauge steel pan with angle iron reinforcement. Choose from a 3/4" rubber mat or 3/4" wood insert deck. Two rigid and two swivel casters with Total Lock brake. Made in USA. Specify color: (02) red, (12) green, (18) blue, (28) gray. (18) blue **IN STOCK.**

Deck LxW	A. 5" POLYURETHANE CASTERS				B. 8" BLACK MOLD-ON RUBBER CASTERS				C. 8" GRAY NON-MARKING RUBBER CASTERS			
	Deck Ht.	Cap. Lbs.	Stock No.	\$	Deck Ht.	Cap. Lbs.	Stock No.	\$	Deck Ht.	Cap. Lbs.	Stock No.	\$
RUBBER												
60x30"	7 1/2"	2000	79541-U	418.00	11 1/8"	2000	79543-U	418.00	10 1/2"	2000	79542-U	431.00
36x24"	7 1/2"	2000	79544-U	252.00	11 1/8"	2000	79546-U	252.00	10 1/2"	2000	79545-U	265.00
48x24"	7 1/2"	2000	79547-U	278.00	11 1/8"	2000	79549-U	278.00	10 1/2"	2000	79548-U	291.00
WOOD												
60x30"	7 1/2"	2000	79550-U	482.00	11 1/8"	2000	79552-U	481.00	10 1/2"	2000	79551-U	494.00
36x24"	7 1/2"	2000	79553-U	392.00	11 1/8"	2000	79555-U	392.00	10 1/2"	2000	79554-U	405.00
48x24"	7 1/2"	2000	79556-U	410.00	11 1/8"	2000	79558-U	467.00	10 1/2"	2000	79557-U	423.00

Ships same day for 1–3 day delivery

Ships 1–5 days



60"L truck with 4 side panels and drop gate, shown with 8" black mold-on rubber casters and optional mat.



60"L truck with 3 side panels, shown with 5" polyurethane casters and optional mat.

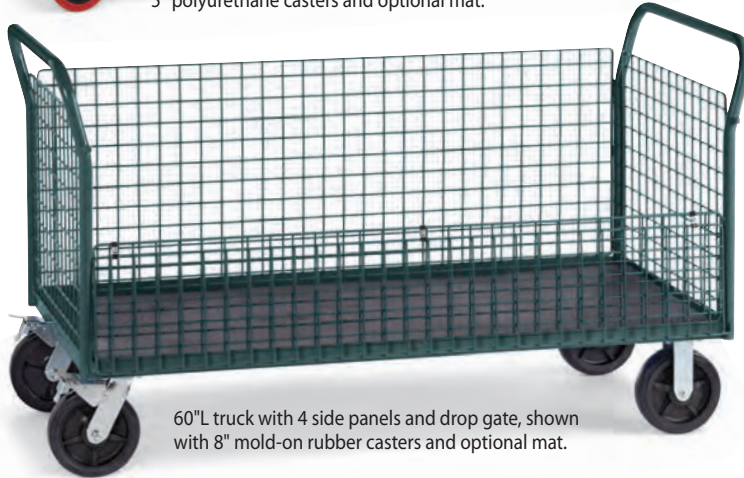

60"L truck with 4 side panels and drop gate, shown with 8" mold-on rubber casters and optional mat.

Choose from 3 caster types



A. 5" polyurethane



B. 8" black mold-on rubber



C. 8" full pneumatic rubber



RUBBERMAID Platform Trucks with Wire Side Panels available, call for information.



48"L truck with 3 side panels, shown with 8" pneumatic casters.

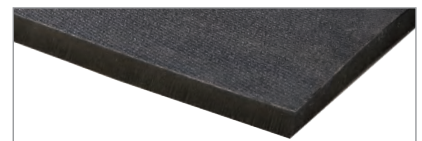

Optional Rubber Mat

100% pure rubber matting with a non-porous, nonskid, long wearing, textured surface. 3/8" thick. Solid underside. 35% softer than concrete; does not stretch. Reduces sound levels. Waterproof. **IN STOCK.**

2836900-U 60"Wx30"D. \$92.00
2837000-U 48"Wx24"D. \$29.00



Premium All-Welded Platform Trucks with Wire Side Panels

- 1200- and 2000-lb. capacities
- 12-gauge steel deck
- 7" and 10" deck heights

Durable all-welded steel platform trucks are available with three or four wire sides. Four-sided truck includes drop gate for easier access to contents. Wire panels provide good visibility and increased air flow. 23"H panels are constructed of 2 1/4" square, 1/4" dia. wire mesh. Mar-resistant powder coat finish. Rolls on 2 rigid and 2 swivel casters. Polyurethane and black mold-on rubber swivel casters include Total Lock brakes. Made in USA. Specify color: (02) red, (12) green, (18) blue, (28) dark gray. (18) blue IN STOCK.

Description	Deck LxW	A. 5" POLYURETHANE CASTERS				B. 8" BLACK MOLD-ON RUBBER CASTERS				C. 8" PNEUMATIC CASTERS			
		Deck Ht.	Cap. Lbs.	Stock Number	\$	Deck Ht.	Cap. Lbs.	Stock Number	\$	Deck Ht.	Cap. Lbs.	Stock Number	\$
4 side panels	48x24"	7"	2000	78976-T	551.00	10"	2000	78978-T	568.00	10"	1200	78980-T	575.00
4 side panels	60x30"	7"	2000	78977-T	581.00	10"	2000	78979-T	607.00	10"	1200	78981-T	613.00
3 side panels	48x24"	7"	2000	78970-T	443.00	10"	2000	78972-T	469.00	10"	1200	78974-T	475.00
3 side panels	60x30"	7"	2000	78971-T	516.00	10"	2000	78973-T	541.00	10"	1200	78975-T	548.00



7706402-U shown with optional wood shelf and 8" black mold-on rubber casters.



7705812-U shown with optional wood shelf and 8" black mold-on rubber casters.



7706118-U shown with 8" black mold-on rubber casters.

ELITE

NEW
STYLES

Wire Security Trucks

- Steel wire
- 2000-lb. capacity
- Multiple caster choices available
- Hardened steel padlock hasp

All-welded 2x2" steel grid panels make this one of the strongest trucks on the market. Provides total security and see-through visibility. Use the plastic shelf clips to attach shelves anywhere on the grid panels (4 shelf clips included with each shelf). Doors include four heavy-duty greasable hinges. 250-lb. capacity shelves are available in 14-gauge steel or 3/4" layered wood. Two swivel with Total Lock brakes, two rigid casters. Painted finish. Padlock not included. Made in USA. **SELECTED MODELS IN STOCK.**

Optional Shelves

Made in USA. For steel shelves, specify color: (02) red, (12) green, (18) blue, (28) dk. gray.

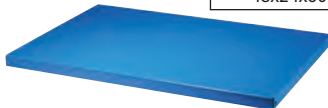

Overall WxD	WOOD		STEEL	
	Stock No.	\$	Stock No.	\$
60x30"	5996600-T	98.10	59635-T	88.80
48x24"	5969600-T	90.30	59634-T	73.50

Optional Panel Inserts

Made in USA. Specify color: (02) red, (12) green, (18) blue, (28) dk. gray.

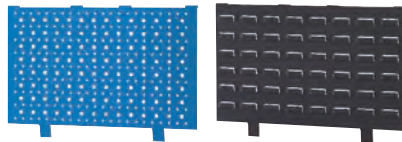

Size	PEGBOARD		LOUVERED	
	Stock No.	\$	Stock No.	\$
23 7/8 x 19"	59737-T	44.70	59738-T	35.70

Optional Rubber Mat

100% pure rubber matting with a non-porous, nonskid, long wearing, textured surface. 3/8" thick. Solid underside. 35% softer than concrete; does not stretch. Reduces sound levels. Waterproof. **IN STOCK.**



Size	Stock No.	\$
60x30"	2837300-U	81.00
48x30"	2836800-U	39.00
48x24"	2837200-U	29.00

Choose from 3 caster types

- A. 5" polyurethane
- B. 8" black mold-on rubber
- C. 8" gray non-marking rubber

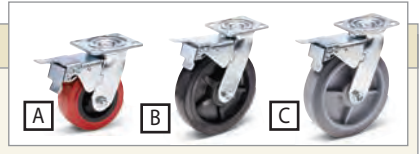

Overall WxDxH	Cap. Lbs.	RED	GREEN	BLUE	DARK GRAY	\$
		Stock No.	Stock No.	Stock No.	Stock No.	
A. 5" POLYURETHANE						
60x30x60"	2000	7705602-U	7705612-U	7705618-U	7705628-U	1406.00
48x30x60"	2000	7705902-U	7705912-U	7705918-U	7705928-U	1266.00
48x24x60"	2000	7706202-U	7706212-U	7706218-U	7706228-U	1078.00
B. 8" BLACK MOLD-ON RUBBER						
60x30x60"	2000	7705802-U	7705812-U	7705818-U	7705828-U	1406.00
48x30x60"	2000	7706102-U	7706112-U	7706118-U	7706128-U	1335.00
48x24x60"	2000	7706402-U	7706412-U	7706418-U	7706428-U	1076.00
C. 8" GRAY NON-MARKING RUBBER						
60x30x60"	2000	7705702-U	7705712-U	7705718-U	7705728-U	1419.00
48x30x60"	2000	7706002-U	7706012-U	7706018-U	7706028-U	1278.00
48x24x60"	2000	7706302-U	7706312-U	7706318-U	7706328-U	1089.00

Shown with optional accessories: steel shelf 59634(18)-T, hitch system 59742(18)-T, fork pockets 59890(18)-T, rubber mat 2837200-U, and louvered panel insert 59738(18)-T.



Accessories. Specify color: (02) red, (12) green, (18) blue, (28) dk. gray.

59742-T	Hitch System. Includes tow bar and hitch.	
	\$	142.00
59890-T	Fork Pockets. Sold in packages of 4.	
	\$ Pkg.	102.00
5973900-T	Sixth-Wheel Swivel Caster Package. Sold in packages of 2.	
	\$ Pkg.	60.70

Ships same day for 1-3 day delivery

Ships 1-5 days



Wire Shelf Trucks



Wire Stock Trucks

Relius Square-Post Wire Trucks with "Smart" Casters

- Steel wire shelves and steel posts
- 1200-lb. capacity
- 5" polyurethane casters

Swivel casters can be locked into one of four rigid positions for maximum cart control. Foot-operated mechanism locks swivel caster. Open-wire shelves adjust in 2" increments. Durable Plating Plus finish. NSF certified. *IN STOCK*.

Wire Shelf Trucks

Shelf WxD	Overall Height	Shelf Qty.	Stock Number	\$
48x18"	60"	4	4791200-W	397.00
60x18"	60"	4	4791300-W	436.00
72x18"	60"	4	4791400-W	469.00
48x24"	60"	4	4791500-W	450.00
60x24"	60"	4	4791600-W	533.00
72x24"	60"	4	4791700-W	581.00
48x18"	70"	4	4792400-W	415.00
60x18"	70"	4	4792500-W	455.00
72x18"	70"	4	4792600-W	491.00
48x24"	70"	4	4792700-W	468.00
60x24"	70"	4	4792800-W	552.00



Smart casters provide better cart maneuverability.

Wire Stock Trucks, 3x3" mesh sides and back.

Shelf WxD	Overall Height	Stock Number	\$
48x18"	70"	4792900-W	652.00
60x18"	70"	4793000-W	608.00
48x24"	70"	4793100-W	744.00
60x24"	70"	4793200-W	864.00



Please call for shelf dividers and ledges.



Shown in gray.

Relius PVC Shelf Liners for Square Post Shelving

Keeps small parts and supplies from falling through open wire shelves. Durable PVC construction. Fits square post shelving. Sold in packs of 2. *FACTORY QUICK SHIP.*

Overall WxD	BLUE	GRAY	\$ Pkg.
	Stock No.	Stock No.	
48x18"	7493018-S	7493027-S	54.80
60x18"	7493118-S	7493127-S	79.00
72x18"	7493218-S	7493227-S	82.00
48x24"	7493318-S	7493327-S	69.50
60x24"	7493418-S	7493427-S	88.00
72x24"	7493518-S	7493527-S	112.00

Choose from 3 caster types



- A. 5" polyurethane
- B. 8" gray non-marking rubber
- C. 8" black mold-on rubber



Shown with 3 optional steel shelves.



Shown with 3 optional wire mesh shelves.



Shelves can be placed slanted or straight.

ELITE Stock Trucks

- Steel
- 660-lb. capacity
- Multiple caster choices available

Choose either powder coated wire mesh or solid steel shelves, sold separately. Shelves can be placed horizontally or tilted in any of 8 shelf mounting slots spaced 5 1/2" apart. Both shelf styles feature a 1 1/2" high lip. Two rigid casters, two swivel casters with Total Lock brakes. Powder coat finish. *IN STOCK.*

Key	Overall WxDxH	Stock No.	\$
A	55 1/2"x25 1/2"x65"	6936001-V	329.00
B	55 1/2"x25 1/2"x65"	6936002-V	344.00
C	55 1/2"x25 1/2"x65"	6936003-V	328.00

6936100-V	Wire shelf. 52"Wx25.6"D. \$	50.00
6936200-V	Solid steel shelf. 52"Wx25.6"D. \$	69.00
2836200-T	Optional rubber shelf mat. \$	86.20



1-shelf, 48x24" model



2-shelf, 36x18" model



3-shelf, 48x24" model



4-shelf, 60x30" model

Available Colors:

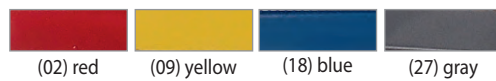

(02) red (09) yellow (18) blue (27) gray

Relius solutions

3-Sided All-Welded Trucks



2400-lb. capacity

- 12-gauge steel
- 2400-lb. capacity
- 6" polyurethane casters

Solid steel base is surrounded by expanded metal sides. Angle iron frames add rigidity and strength to side walls. Easy-to-manuever trucks feature a push handle on one end and 2 rigid, 2 swivel casters. Powder coat finish is standard. Ships set up. Made in USA. Specify color: (02) red, (09) yellow, (18) blue, (27) gray.

Shelf WxD	Overall Height	Shelf Qty.	Shelf Clearance	Stock Number	\$
36x18"	55 1/2"	2	23"	48656-S	443.00
36x18"	55 1/2"	3	14"	48665-S	499.00
42x24"	55 1/2"	2	23"	48657-S	504.00
42x24"	55 1/2"	3	14"	48666-S	569.00
48x24"	55 1/2"	1	—	48649-S	453.00
48x24"	55 1/2"	2	23"	48658-S	524.00
48x24"	55 1/2"	3	14"	48667-S	599.00
60x24"	55 1/2"	2	23"	48659-S	561.00
60x24"	55 1/2"	3	14"	48668-S	656.00
60x24"	55 1/2"	4	10"	48767-S	735.00
60x30"	55 1/2"	2	23"	48662-S	634.00
60x30"	55 1/2"	3	14"	48671-S	726.00
60x30"	55 1/2"	4	10"	48784-S	819.00
72x36"	55 1/2"	1	—	48655-S	621.00
72x36"	55 1/2"	3	14"	48677-S	927.00

Ships same day for 1-3 day delivery

Ships 1-5 days



65201(18)-U shown with 5" polyurethane casters and optional mat.



Please call for:

- Writing shelf
- Pull-out shelf
- Middle shelf
- Shelf mat
- Two drawers (available for 24"D models)

Also available in:

- (02) red
- (12) green
- (28) gray

ELITE All-Welded Utility Carts

- 12-gauge steel
- Multiple caster choices available
- 2000-lb. capacity
- All-welded

Built for rigidity and long service life. Shelves have 1 1/2" lips are supported by 1 1/2"x1 1/2", 1/8" thick uprights. Long-wearing, enamel finish. Made in USA. Specify color: (02) red, (12) green, (18) blue, (28) gray. (18) blue *IN STOCK*.



Shelf WxD	Shelf Qty.	Shelf Clearance	5" POLYURETHANE				8" BLACK MOLD-ON RUBBER				8" GRAY NON-MARKING RUBBER			
			Overall Height	Cap. Lbs.	Stock Number	\$	Overall Height	Cap. Lbs.	Stock Number	\$	Overall Height	Cap. Lbs.	Stock Number	\$
36 1/2"x18 1/4"	2	26"	36"	2000	65201-U	414.00	39"	2000	65203-U	414.00	39"	2000	65202-U	427.00
36 1/2"x24 1/4"	2	26"	36"	2000	65204-U	426.00	39"	2000	65206-U	426.00	39"	2000	65205-U	439.00
48 1/2"x24 1/4"	2	26"	36"	2000	65207-U	440.00	39"	2000	65209-U	439.00	39"	2000	65208-U	452.00



Shown with 8" gray non-marking rubber casters and optional mat.



2000-LB. CAPACITY

Also available in:

- (02) red
- (12) green
- (28) gray

Please call for:

- Writing shelf
- Pull-out shelf
- Middle shelf
- Shelf mat
- Two drawers (available for 24 1/2"D models)

ELITE Premium Multi-Use Carts with Ergonomic Handle

- 12-gauge steel
- Multiple caster choices available
- 2000-lb. capacity
- All-welded

Cart features 1 1/2"D lips on upper and lower shelf to prevent items from rolling off during transport. Ergonomic handle is placed at a comfortable height for proper posture. Two rigid, two swivel casters with Total Lock brakes. Build your own customized utility cart by adding premium high-quality accessories, sold separately below. Made in USA. Specify color: (02) red, (12) green, (18) blue, (28) gray. (18) blue *IN STOCK*.



Shelf WxD	Shelf Qty.	Shelf Clearance	Cap. Lbs.	5" POLYURETHANE			8" BLACK MOLD-ON RUBBER			8" GRAY NON-MARKING RUBBER		
				Overall Ht.	Stock No.	\$	Overall Ht.	Stock No.	\$	Overall Ht.	Stock No.	\$
36 1/2"x18 1/4"	2	26"	2000	36"	64730-U	350.00	39"	64732-U	350.00	39"	64731-U	362.00
36 1/2"x24 1/4"	2	26"	2000	36"	64733-U	376.00	39"	64735-U	376.00	39"	64734-U	389.00
48 1/2"x24 1/4"	2	26"	2000	36"	64736-U	396.00	39"	64738-U	396.00	39"	64737-U	409.00



Rubber mat shelf cart shown with 8" black mold-on rubber casters.



Wood shelf cart shown with 5" polyurethane casters.



General-Purpose Utility Carts

- Steel
- 1000-lb. overall capacity; 500-lb. capacity per shelf, evenly distributed
- Multiple casters choices available
- All-welded

Two shelf styles to meet your specific material handling needs. Choose .624" thick wood shelves with polyurethane finish or rubber mat shelves. Shelves are flush with frame. Bolted push handle and four casters—two fixed, two swivel with Total Lock brakes. Powder coat finish. *IN STOCK*.

Shelf WxD	Overall Height	Shelf Qty.	Shelf Clearance	5" POLYURETHANE		8" BLACK MOLD-ON RUBBER		8" GRAY NON-MARKING RUBBER	
				Stock Number	\$	Stock Number	\$	Stock Number	\$
RUBBER MAT									
36 1/2"x24 1/4"	36"	2	26"	7754901-U	539.00	7754903-U	538.00	7754902-U	488.00
WOOD									
36 1/2"x24 1/4"	36"	2	26"	7755201-U	724.00	7755203-U	724.00	7755202-U	737.00



Tray-Shelf Carts with Nickel Legs

- Polyethylene structural foam shelves
- 300-lb. capacity
- Rubber casters
- Molded push handle

Constructed from high-density polyethylene structural foam molded plastic shelves and legs that won't stain, scratch, dent or rust. Choose from flush top shelf for easier loading/unloading or cart with 2 3/4" deep tub shelf to keep items in place. Retaining lip around the back and sides of flat shelves. Rolls on heavy-duty 4" swivel casters, 2 with brakes.

Made in USA. *IN STOCK.*



Two-shelf tub top cart.



Three-shelf flush top cart.

Shelf Qty.	Shelf WxD	Overall Height	Shelf Clearance	TUB TOP		FLUSH TOP	
				Stock No.	\$	Stock No.	\$
2	24x18"	34 1/4"	26"	2304801-V	85.00	2304802-V	85.00
3	24x18"	38 1/2"	12"	2304901-V	109.00	2304902-V	109.00



Economical Tray-Shelf Carts

- Structural foam
- 500-lb. capacity
- 5" non-marking rubber casters
- Molded push handle

All the high-quality features and construction of competitors' models at an affordable price. Durable cart will not rust, dent, chip or peel. Includes leakproof top and rounded corners. Gray casters—2 fixed, 2 swivel. Color: gray. Made in USA. *IN STOCK.*



Shelf WxD	Overall Height	Shelf Qty.	Shelf Clearance	Stock Number	\$
30x16"	32 1/4"	2	18 7/8"	7924527-T	149.00
36x24"	32 1/4"	2	18 7/8"	7924627-T	175.00

Replacement Rubber Casters. Order in quantities of 2, priced each.

Description	Caster Ht.	Stock No.	\$(2+)
Rigid	5"	5962901-S	15.70
Swivel	5"	5962902-S	15.70

Call for additional sizes and styles of carts



RELIUS SOLUTIONS High-Capacity Utility Carts



HERCULES Premium Shop Carts



RELIUS ELITE Flush-Shelf Shop Carts



RELIUS SOLUTIONS Wire Utility Carts



RELIUS ELITE Stainless Steel Carts

Ships same day for 1-3 day delivery

Ships 1-5 days



Extra Length Rolls = 100' of stretch wrap FREE!

Relius solutions **Blown Stretch Wrap**

Get an extra 100' of stretch wrap FREE on every roll. Withstands the most severe protrusions, sharp edges, and shipping hazards without compromise. 3" core. Order in quantities of 4, priced each. Made in USA. *IN STOCK.*

Roll WxL		Gauge/ Micron	Stock Number	\$ Roll (4+)	\$ Roll (24+)
12"x2100'	305mmx640m	60/15	3368300-W	20.80	19.80
15"x2100'	381mmx640m	60/15	3368400-W	26.00	24.70
18"x2100'	457mmx640m	60/15	3368500-W	31.22	29.70
12"x1600'	305mmx488m	80/20	3368600-W	25.70	24.50
15"x1600'	381mmx488m	80/20	3368700-W	32.40	30.80
18"x1600'	457mmx488m	80/20	3368800-W	32.00	30.40
12"x1600'	305mmx488m	90/23	3368900-W	24.00	22.80
15"x1600'	381mmx488m	90/23	3369000-W	30.00	28.50
18"x1600'	457mmx488m	90/23	3369100-W	35.70	34.00



Relius solutions **Banding Stretch Wrap**

An economical replacement for strapping or tape. Self-adhesive cast wrap sticks only to itself without harming products or leaving sticky residues. Includes a dispenser. Order in case quantities specified, priced each. Made in USA. *IN STOCK.*

Roll WxL		Gauge/ Micron	Case Qty.	Stock Number	\$	\$ (6+)
2"x1000'	51mmx305m	80/20	24	8180000-W	5.40	5.20
2"x700'	51mmx213m	120/30	24	8180100-W	5.90	5.70
3"x1000'	76mmx305m	80/20	18	8180200-W	8.00	7.60
3"x700'	76mmx213m	120/30	18	8180300-W	8.60	8.20
3"x650'	76mmx198m	135/34	18	8180400-W	8.50	8.10
3"x600'	76mmx183m	150/38	18	8180500-W	7.80	7.50
5"x1000'	127mmx305m	60/15	12	8180600-W	11.80	11.30
5"x1000'	127mmx305m	80/20	12	8180700-W	13.30	12.70
5"x700'	127mmx213m	120/30	12	8180800-W	14.30	13.60
5"x650'	127mmx198m	135/34	12	8180900-W	13.90	13.30
5"x600'	127mmx183m	150/38	12	8181000-W	14.60	13.90



Extra Length Rolls = 100' of stretch wrap FREE!

Relius solutions **Cast Stretch Wrap**

Get an extra 100' of stretch wrap FREE on every roll. 3" core. Order in quantities of 4, priced each. Made in USA. *IN STOCK.*

Roll WxL		Gauge/ Micron	Stock Number	\$ Roll	\$ Roll (24+)
12"x2100'	305mmx640m	60/15	3367000-V	17.40	16.60
15"x2100'	381mmx640m	60/15	3367100-V	21.40	20.40
18"x2100'	457mmx640m	60/15	3367200-V	25.70	24.50
12"x2100'	305mmx640m	70/18	3367300-V	19.70	18.80
15"x2100'	381mmx640m	70/18	3367400-V	24.70	23.50
18"x2100'	457mmx640m	70/18	3367500-V	29.00	27.60
12"x1600'	305mmx488m	80/20	3367600-V	16.90	16.10
15"x1600'	381mmx488m	80/20	3367700-V	20.70	19.70
18"x1600'	457mmx488m	80/20	3367800-V	25.00	23.80
12"x1600'	305mmx488m	90/23	3367900-V	18.70	17.80
15"x1600'	381mmx488m	90/23	3368000-V	23.30	22.20
18"x1600'	457mmx488m	90/23	3368100-V	27.60	26.30
18"x1100'	457mmx335m	120/30	3368200-V	24.80	23.60

Portability package, stainless steel with NEMA 4x controls for washdown capabilities, tapered chutes to handle narrow containers, and higher dump heights are available, please call for more assistance.

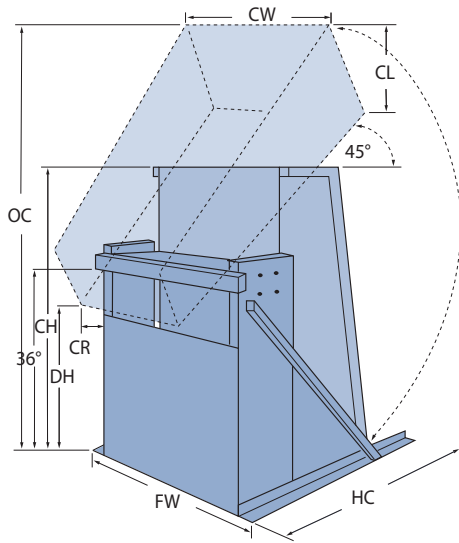

Hold-down bar adjusts from 30-42" to handle 28-40" containers.



Please call for steel bulk containers.



Premium Box Dumpers

- All-welded steel
- Up to 6000-lb. capacity



Dumps completely in less than one minute. Chutes have a 1/4" plate steel base with 7-ga. sides. Dumpers are fully powered up and gravity down and include an overload-protected 2 HP motor with a NEMA 12 magnetic starter.* Push-button control is mounted to side of dumper. Includes dead man's switch that automatically stops machine if operator should become incapacitated. Dumper bolts to floor. 3-phase, 460V. Made in USA.

Dump Height DH	Chute Length CL	Chute Width CW	Chute Reach CR	Chute Height CH	Frame Width FW	Horizontal Clearance HC	Overhead Clearance OC	2000-LB. CAPACITY		4000-LB. CAPACITY		6000-LB. CAPACITY	
								Stock No.	\$	Stock No.	\$	Stock No.	\$
36"	36"	36"	12 1/2"	66"	51"	72"	111"	7435301-S	6647.00	7454301-S	8296.00	7459202-S	8383.00
36"	48"	51"	12 1/2"	66"	66"	81"	119"	7443801-S	6906.00	7454701-S	8200.00	7459901-S	8477.00
48"	36"	36"	10"	72"	51"	79"	127"	7473901-S	6635.00	7474301-S	7927.00	7459301-S	8535.00
48"	48"	51"	10"	72"	66"	87"	135"	7449401-S	6853.00	7454801-S	8147.00	7460101-S	8759.00
60"	36"	36"	5"	72"	51"	83"	138"	7443301-S	6860.00	7465801-S	8200.00	7459401-S	8648.00
60"	48"	51"	5"	72"	66"	91"	146"	7475601-S	7074.00	7453501-S	8422.00	7453601-S	8694.00
72"	36"	36"	5"	84"	51"	148"	150"	5710801-S	8072.00	5710901-S**	9129.00	5711001-S**	9564.00
72"	48"	51"	5"	84"	66"	156"	158"	5711101-S	8052.00	5711201-S**	9628.00	5711301-S**	10073.00

*Standard units not intended for continuous use. Rated for 10% duty cycle. If required, customization for continuous-use motors available upon request.

**Models with 72" dump height and 4000- or 6000-lb. capacities have a chute that's elevated 12" off the floor. A fork truck is required for loading/unloading.

Handles These Containers:

- Bulk containers
- Cartons
- Gaylords
- Totes
- Troughs
- Tubs
- Poly containers
- Vats
- Corrugated steel containers

Customize your dumper with options that meet your specific material handling requirements. Call us for these custom options:

- 1-Phase, 110V power
- Power Up-Power Down (Chute hydraulically raises and lowers)
- Maintained Contact Button (Cycles dumper to first limit switch stop position)
- Custom-Height Hold-Down Bar
- Foot Control or Pendant Control
- Additional Paint Choices: Sand, Dark Gray, or Steel It FDA Approved Epoxy Paint



Ships same day for 1-3 day delivery

Ships 1-5 days

CONTACT US! ALL PRICES WILL BE FURTHER DISCOUNTED!
CALL DICK JONES SALES 800-441-9955

EXCLUSIVE BRANDS!



AS LOW AS
\$18²⁰



Don't see the trash can you need?
Please call!



Waste Containers

- One-piece molded polyethylene construction is leakproof and easy to clean
- Contour design prevents jamming when nesting containers
- Lid not included

Made in USA. *IN STOCK.*

Description	Stock No.	\$ SAVE
32-gal. container	3375627-S	18.20
44-gal. container	3375727-S	27.00



AS LOW AS
\$192⁰⁰

Please call for more
Relius Solutions
products.



Dome Receptacles

- UL-listed container features fire-safe construction
- Stainless steel rolled bottom bands prevent corrosion
- Galvanized liner
- 15-gallon capacity

Made in USA. *Specify color: (29) black, (30) white, (33) almond. SELECTED MODELS IN STOCK.*

Description	Stock No.	\$ SAVE
Spring-Loaded Top	45857-T	193.00
Funnel Top	45789-T	192.00