

hand sheving USA quality
custom
aluminum pallets
directional equipment
delivery tables stock
racks utility
delivery pallets carts tables
ladders
t
ed e
rand



Material Handling
2012 Idea Book

die = fabrication
 aluminum
 saw
 extrusion
 USA Made
 turret
 billet
 press
 punch
 robots
 shipping
 welding
 NAI
 aluminum sheet



New Age began manufacturing in 1966. Forty-five years later, we are the leading aluminum manufacturer in the USA. New Age operates out of a 200,000 square foot facility located in the "Heartland of America" in Norton, Kansas. Our rural workforce has a very strong work ethic and a true understanding of what the word "quality" means.

New Age Industrial is more than just another supplier. New Age buys pure primary grade aluminum billet. We extrude our own aluminum to fit our customers' needs. By controlling the extrusion process, we have unlimited flexibility in product design and durability. Our aging oven gives the aluminum its temper or hardness, ensuring its shape for the duration of its lifetime. New Age has the state of the art computer controlled equipment to maintain the high quality standards that are essential in the welding process. New Age is focused on building aluminum products only, insuring that all our welders are highly skilled at giving a precision weld joint every time.

Our engineering department takes pride in developing and designing products that solve our customers' needs.



Table Of Contents

| | | | | |
|---|--------------|---|---|-----------|
| CABINETS (Enclosed) | 36, 60 | PALLETS | Table Mount Cantilever Shelves..... | 56 |
| CARTS | | Tube Frame Pallets | Wall / Ceiling Uprights | 52 |
| Bulk Delivery Carts | 9-10 | FDA Channel Pallets | Mega Duty-Shelving | 50 |
| Cage Carts | 23 | Forklift Order Picking Pallets/Carts..... | Wall Shelves | |
| Carrier Carts | 23 | Forklift Picking Pallets | Inverted Shelves..... | 50 |
| Folding L Carts | 7 | Raised Platform Picking Pallet | Solid Wall Shelves..... | 50 |
| Folding Utility Cart | 7-10 | Hand Truck Pallet | T-Bar Wall Shelves..... | 50 |
| Heavy Duty Utility Cart | 13 | | T-Bar with Hanger Shelves..... | 50 |
| Lean Manufacturing "Kitting" Carts..... | 37 | PICKING | | |
| Low Boy Cart | 7 | "Build Your Own" Picking Cart | SPECIALITY | |
| Mat Cart..... | 59 | Forklift Order Picking Carts/Pallets..... | Aluminum Corners..... | 58 |
| Merchandise Cart | 7 | Forklift Picking Platform..... | Aluminum Cove..... | 58 |
| Tubular Deck Cart..... | 17 | Raised Platform Picking Pallet | Aluminum Floor Grating..... | 58 |
| U-Boat Carts..... | 8 | "Test Drive" Cart | | |
| Utility Cart..... | 14 | Two/Three Tier Picking Carts | SPECIAL PURPOSE CARTS | |
| CASTERS | 64 | Tote Bin Picking Carts | Floral Cart..... | 15 |
| CUSTOMS ...1, 5-6, 9, 11-14, 17- 23, 25-26, 28-30, 36-37 | | "Pick To Light" Conveyor Sled | Wet Product Carts | 16 |
| DOLLIES | | Picking Tote Carts..... | | |
| Flat Dollies..... | 39 | Multiple Tier Picking Carts..... | | |
| Keg Dolly | 4 | | TABLES | |
| Multi-Directional RotaCaster Dollies..... | 38 | RACKS | Poly Top Tables..... | 55 |
| Super Dollies | 39 | Narrow Universal Tray Racks..... | Stainless Steel Top Tables..... | 54 |
| Trash Can Dolly | 38 | Poly Box Storage Racks..... | Table Accessories..... | 57 |
| Tray Dollies..... | 39 | Tray Racks..... | Table Mount Cantilever Over Shelves | 56 |
| DUNNAGE RACKS | | Universal Racks..... | | |
| Mobile Dunnage Racks | 40 | | TRUCKS | |
| Stationary Dunnage Racks..... | 40-41 | RAMPS | Box Truck..... | 11 |
| EQUIPMENT STANDS | | Arched Ramps..... | Bulk Delivery Trucks | 9-10 |
| Mobile Equipment Stands..... | 41-42 | Curb/Threshold Ramp | Freezer Trucks..... | 33 |
| Stationary Equipment Stands | 41-42 | Hinged Ramps..... | Heavy Duty Multi-Shelf Aluminum Truck .. | 12 |
| HAND TRUCKS | | | Heavy Duty Multi-Shelf Stainless Steel Truck... | 12 |
| RotaTruck Barrel Back/Keg Carrier Hand Truck ... | 3 | SECURITY CAGES | Heavy Duty Stock Truck | 14 |
| RotaTruck Self-Supporting Hand Truck..... | 3 | | Heavy Duty Utility Trucks..... | 13 |
| RotaTruck Stair Climbing Hand Truck | 3 | SECURITY FENCE | Platform Trucks..... | 5-6 |
| Two Wheel Hand Truck | 1-2 | | Utility Stock Truck..... | 17 |
| HOPPER BOTTOM BINS "I.B.C." | 24 | SHELVING | Uni-T Truck..... | 11 |
| INDEX | 66-67 | <i>Adjustable Shelving</i> | | |
| LADDER CARTS | 29-30 | Adjustable H.D. Shelving..... | WARRANTY | 65 |
| LUG TUB / BULK BIN CARTS | | Adjustable T-Bar Shelving | WORKSTATIONS | |
| Bulk Bins & Lids..... | 33 | Adjustable Solid Shelving | Retractable Wall Mount | 53 |
| Bulk Carts | 33 | Adjust-A-Shelf Posts & Accessories | Ergonomic Mobile Workstation/Tilt Cart ... | 15 |
| Lug Carts..... | 31-32 | Adjust-A-Shelf Heavy Duty Series | | |
| Lug Tubs & Lids..... | 31 | Adjust-A-Shelf Solid Brute Series | | |
| Lug Plus/Channel Slide Carts..... | 31 | Adjust-A-Shelf T-Bar Series..... | | |
| Universal Lug Tub Carts | 33 | Mobile Bases..... | | |
| OPTIONS | 63 | | | |
| ORDERING INFORMATION | 65 | <i>All Welded Shelving</i> | | |
| | | All Welded Heavy Duty Shelving | | |
| | | All Welded T-Bar Shelving | | |
| | | <i>Cantilever Shelving</i> | | |
| | | Adjustable HD Heavy Duty Shelves | | |
| | | Adjustable SB Solid Reinforced Shelves..... | | |
| | | Adjustable T-Bar Shelves | | |
| | | Free Standing Braces..... | | |
| | | Free Standing Uprights..... | | |
| | | Stor-A-Shelf | | |



Hand Trucks



#HT18F10

| Model No. | Size W-H-D | Wheel Type | Ship Wt. |
|-----------|-----------------------------|------------|----------|
| HT18F10 | 22-1/2" x 53-1/2" x 19-1/2" | Flat Free | 39# |
| HT18P10 | 22-1/2" x 53-1/2" x 19-1/2" | Pneumatic | 39# |
| HT18NC | 18" x 53-1/2" x 16-1/4" | No Casters | 29# |

Stair glide wear strips are standard.

Wheels:

- HT18F10 - (2) 3-1/2" x 10" Flat Free Wheels (#C559)
- HT18P10 - (2)3-1/2" x 10" Pneumatic Wheels (#C560)
- HT18NC - Includes 5/8" DIA. Axle.



Replacement:

47092.... Stair Glide Wear Strips (2).

- Heavy duty, all welded design.
- Lightweight aluminum.
- Removable foot plate (9" x 18").
- Weight Capacity = 750#
- For transporting heavy loads from the back room to the floor.
- Lifetime warranty against rust and corrosion.



Hand Trucks Dual Grip, Barrel Back



#99677

| Model No. | Size W-H-D | Wheel Type | Ship Wt. |
|-----------|-------------------------|------------|----------|
| 99677 | 18" x 53-1/2" x 19-1/2" | Flat Free | 33# |
| 99677PNU | 18" x 53-1/2" x 19-1/2" | Pneumatic | 31# |
| 99677NC | 18" x 53-1/2" x 16-1/4" | No Casters | 23# |

Stair glide wear strips are standard.

Wheels:

- 99677 - (2) 3-1/2" x 10" Flat Free Wheels (#C559).
- 99677PNU - (2)3-1/2" x 10" Pneumatic Wheels (#C560).
- 99677NC - Includes 5/8" DIA. Axle.



Replacement:

47092.... Stair Glide Wear Strips (2).

- Lightweight, all welded aluminum construction.
- Weight Capacity = 750#.
- Rounded back to cradle barrels.
- Designed to reduce fatigue and injury in the workplace.
- Equipped with removable/replaceable nose plate.
- Lifetime warranty against rust and corrosion.



"Don't Compromise....Customize."



#99244



#98297



Hand Trucks Dual Grip

| Model No. | Size W-H-D | Wheel Type | Ship Wt. |
|-----------|-------------------------|------------|----------|
| 99676F | 18" x 53-1/2" x 19-1/2" | Flat Free | 33# |
| 99676P | 18" x 53-1/2" x 19-1/2" | Pneumatic | 31# |
| 99524F | 18" x 60" x 19-1/2" | Flat Free | 34# |
| 99524P | 18" x 60" x 19-1/2" | Pneumatic | 32# |
| 99676NC | 18" x 53-1/2" x 16-1/4" | No Casters | 29# |
| 99524NC | 18" x 60" x 16-1/4" | No Casters | 23# |

Stair glide wear strips are standard.

Wheels:

- 99676F & 99524F - (2) 3-1/2" x 10" Flat Free Wheels (#C559)
- 99676P & 99524P - (2) 3-1/2" x 10" Pneumatic Wheels (#C560)
- 99676NC & 99524NC - Includes 5/8" DIA. Axle

Replacement:

47092.... Stair Glide Wear Strips (2).



- Dual-grip handles.
- Lightweight, all welded aluminum construction.
- Weight Capacity = 750#.
- Removable/Replaceable nose plate.
- Hoop top, 1" pipe handle for easy handling.
- Lifetime warranty against rust and corrosion.



#99676

#99524



Hand Truck Pallet

| Model No. | Size W-H-D | Wt. Cap. | Ship Wt. |
|-----------|------------------------|----------|----------|
| 99627 | 21" x 1-1/2" x 15-1/2" | 750# | 3# |

Nose Plate Opening = 18-1/2"W x 3/4"H
Custom sizes available.

- Labor saving pallet allows movement of product without loading and unloading.
- Eliminates hand truck nose plate from scratching floors.
- All welded, lightweight aluminum construction.
- Designed to reduce damaged product.
- Ideal for route delivery trucks.
- Lifetime warranty against rust and corrosion.

You Tube > <http://www.youtube.com/user/NewAgeInd#p/u/8/9ifh6PsCQdc>



#99627



Rotatruck Self-Supporting

You Tube > <http://www.youtube.com/user/NewAgeInd#p/u/10/s6wpjtb2GY>



#RTS18

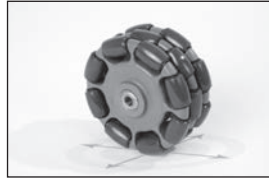

Rotacaster wheels have the ability to move in any direction while mounted to a fixed position - Using rollers rather than a swivel mount. They are designed to reduce fatigue and injury in the workplace

| Model No. | Size W-H-D | Wt. Cap. | Ship Wt. |
|------------|------------------------------|-----------|----------|
| RTS18..... | 21-3/4" x 53-1/2" x 22-1/16" | 800#..... | 38# |

Equipped with Rotacaster wheels (#C568).

- Self-supporting design makes it easy to maneuver with little effort.
- Multidirectional wheels with lateral movement.
- Loads upright like traditional hand trucks and is supported by dual caster rigs when inclined.
- All welded frame with removable plate.
- Lifetime warranty against rust and corrosion.



Rotatruck Stair-Climber

You Tube > http://www.youtube.com/user/NewAgeInd#p/u/11/ULWRV_N9ugY



#RTC18



#RTC18DG



Rotacaster wheels have the ability to move in any direction while mounted to a fixed position - Using rollers rather than a swivel mount. They are designed to reduce fatigue and injury in the workplace

| Model No. | Size W-H-D | Wt. Cap. | Ship Wt. |
|-------------|------------------------------|-----------|----------|
| RTC18..... | 21-3/4" x 53-1/2" x 22-1/16" | 800#..... | 43# |
| RTC18DG ... | 21-3/4" x 53-1/2" x 22-1/16" | 800#..... | 43# |

Equipped with Rotacaster wheels (#C568).
Stair glide wear strips are standard.

Replacement:
47092.... Stair Glide Wear Strips (2).

- Multidirectional wheels with lateral movement.
- Wheels rotate on a center axis, allowing you to go up or down stairs.
- Not designed for use on open-back stairs.
- Designed to reduce fatigue and injury in the workplace.
- All welded frame with removable plate.
- Lifetime warranty against rust and corrosion.



Rotatruck Barrel Back Stair-Climber

You Tube > <http://www.youtube.com/user/NewAgeInd#p/u/5/KQB80FvFFPA>



#RTCB16



Rotacaster wheels have the ability to move in any direction while mounted to a fixed position - Using rollers rather than a swivel mount. They are designed to reduce fatigue and injury in the workplace

| Model No. | Size W-H-D | Wt. Cap. | Ship Wt. |
|------------|-------------------------|-----------|----------|
| RTCB16.... | 18-1/4" x 51-1/4" x 20" | 800#..... | 40# |

Equipped with Rotacaster stairclimber wheels (#C568).
Stair glide wear strips are standard.

Replacement:
47092.... Stair Glide Wear Strips (2).



- Multidirectional wheels with lateral movement.
- Rounded back to cradle barrels.
- Wheels rotate on a center axis, allowing you to go up or down stairs.
- Not designed for use on open-back stairs.
- Designed to reduce fatigue and injury in the workplace.
- All welded frame with removable plate (9" x 16").
- Lifetime warranty against rust and corrosion.



Curb / Threshold Ramp

| Model No. | Size W-H-L | Weight Capacity | Ship Wt. |
|-----------|--------------------------------------|-----------------|----------|
| 50172 | 27" x 27" O.D. 26-1/2" x 27" I.D. | 750# | 16# |

Fitted with anti-slip traction tape for secure footing.

- 2" x 5" Hand cutout for carrying or hanging in a delivery truck.
- 1-1/2" High safety side rail.
- Flat transition top with stops underneath keeps ramp secure against curb when in use.
- Lifetime warranty against rust and corrosion.

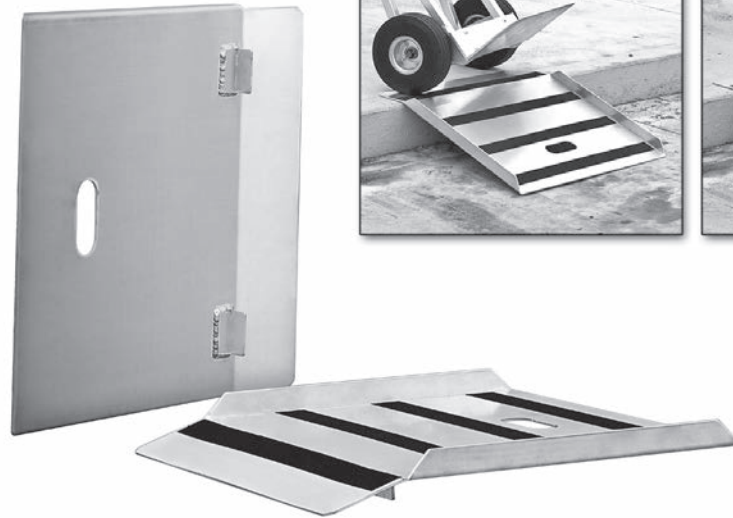
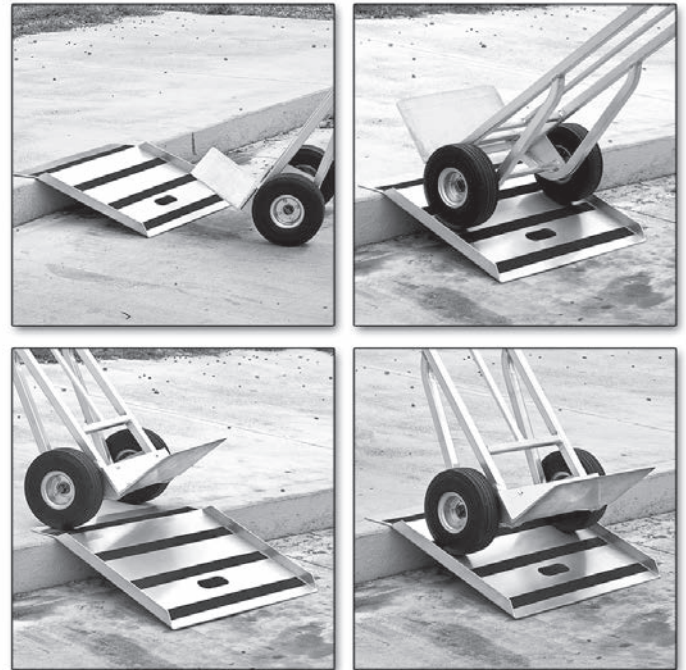

#50172

Keg Dolly

| Model No. | Size W-H-L | Weight Capacity | Ship Wt. |
|-----------|----------------------------|-----------------|----------|
| 98037 | 17-1/4" x 5-1/4" x 17-1/4" | 175# | 15# |

Accommodates 1/4 and 1/2 Barrel Kegs up to 16-3/4" in diameter. Four 3" platform type casters (#C410).

- Low profile for easy loading.
- Three sides secured with tab upward, one side open for easy loading/unloading.
- 3" swivel plate casters.
- Lifetime warranty against rust and corrosion.



#98037



U-Shaped Platform Truck



#99321

| Model No. | Size W-H-L | Deck Size | Wt. Cap. | Ship Wt. |
|-----------|-------------------------|-----------|----------|----------|
| 99320 | 20" x 44-1/2" x 36-1/2" | 20" x 36" | 2000# | 47# |
| 99321 | 20" x 44-1/2" x 48-1/2" | 20" x 48" | 2000# | 50# |
| 99322 | 20" x 44-1/2" x 60-1/2" | 20" x 60" | 2000# | 53# |
| 99323 | 30" x 44-1/2" x 48-1/2" | 30" x 48" | 2000# | 57# |
| 99324 | 30" x 44-1/2" x 60-1/2" | 30" x 60" | 2000# | 61# |

Four 8"x2" platform type casters - 2 swivel (#C526), 2 rigid (#C527).

Options:

"CL(C)", "PB", "PP(C)"— see page 63 for details.

- Channel deck for heavy duty loads and easy cleaning.
- Deck Height = 11-1/4"
- Rounded nose decreases damaged walls and doors.
- Removable tube handle.
- Lifetime warranty against rust and corrosion.



Folding Platform Truck



#98667

| Model No. | Size W-H-D | Position | Wt. Cap. | Ship Wt. |
|-----------|--------------------------|----------|----------|----------|
| 98667 | 26-1/4" x 51-9/16" x 48" | Unfolded | 800# | 68# |
| | 26-1/4" x 12" x 48" | Folded | | |

Four 6" heavy duty plate casters - 2 swivel (#C530), 2 rigid (#C531).

- Handle folds up for easy storage.
- Has 8-3/4 square feet of deck space... Takes up less than 3 square feet of storage space.
- For transporting heavy loads from the back room to the floor.
- Lifetime warranty against rust and corrosion.



"Don't Compromise....Customize."



#99733



#99631



#99361



Aluminum Platform Truck

| Model No. | Size W-H-L | Deck Size | Wt. Cap. | Ship Wt. |
|---|-----------------|-----------|----------|----------|
| PLATFORM TRUCK WITH SMOOTH DECK | | | | |
| PT2436S6..... | 24" x 41" x 39" | 24" x 36" | 2600# | 59# |
| PT2448S6..... | 24" x 41" x 51" | 24" x 48" | 2600# | 64# |
| PT3048S6..... | 30" x 41" x 51" | 30" x 48" | 2600# | 73# |
| PT3060S6..... | 30" x 41" x 63" | 30" x 60" | 2600# | 80# |
| PT3660S6..... | 36" x 41" x 63" | 36" x 60" | 2600# | 87# |
| PT3672S6..... | 36" x 41" x 75" | 36" x 72" | 2600# | 93# |
| PLATFORM TRUCK WITH TREAD PLATE DECK | | | | |
| PT2436P6..... | 24" x 41" x 39" | 24" x 36" | 2600# | 58# |
| PT2448P6..... | 24" x 41" x 51" | 24" x 48" | 2600# | 63# |
| PT3048P6..... | 30" x 41" x 51" | 30" x 48" | 2600# | 71# |
| PT3060P6..... | 30" x 41" x 63" | 30" x 60" | 2600# | 78# |
| PT3660P6..... | 36" x 41" x 63" | 36" x 60" | 2600# | 85# |
| PT3672P6..... | 36" x 41" x 75" | 36" x 72" | 2600# | 90# |



Smooth Deck



Tread Plate Deck with optional extra handle

Four 6"x2" heavy duty "TPR" tread plate casters - 2 swivel (#C510), 2 rigid (#C518).

Options:

"CL(C)", "PB", "PP(C)"— see page 63 for details.

Caster Upgrade -- Replace last digit of model # with "8".
Consists of four 8" x 2" heavy duty polyurethane tread plate casters
— 2 swivel (#C526), 2 rigid (#C527).

Extra Handle -

- #60328..... For **24" Wide** Units
- #60329..... For **30" Wide** Units
- #60330..... For **36" Wide** Units

- Aluminum deck, 1/8" thick, with smooth or tread plate.
- Removable, heavy duty handle — standard.
— Double handle optional.
- Optional perimeter bumper.



"Don't Compromise...Customize."



#98527T



#98752

Little changes don't have to cost big money.

At New Age, we know what a big difference little changes can make. That's why we pride ourselves on customer-friendly customizing. We control the manufacturing process from start-to-finish, thus controlling the cost.

Whether you want to accommodate a specific box or tote, make a unit wider, narrower, shorter, taller, etc... we have the capability to deliver it in a fast, economical fashion.



General Merchandise Cart



#95370

| Model No. | Size W-H-L | Wt. Cap. | Deck Ht. | No. Casters | Ship Wt. |
|-----------|-------------------------|----------|----------|-------------|----------|
| 95370 | 20" x 52-3/8" x 55-1/4" | 1200# | 9" | 6 | 55# |

Six casters - four 5" swivel (#C450) and two 2" x 6" rigid (#C518).

- Folds up and stores on end to save storage space.
- Has 6-3/4 square feet of deck space... Takes up 2-1/4 square feet of storage space.
- For transporting heavy loads from the back room to the floor.
- Center rigid casters allow for zero turning radius.
- Lifetime warranty against rust and corrosion.



Folding "L" Cart



#95241

| Model No. | Size W-H-L | Wt. Cap. | Deck Ht. | No. Casters | Ship Wt. |
|-----------|-----------------|----------|----------|-------------|----------|
| 95241 | 18" x 63" x 62" | 1200# | 9-1/8" | 6 | 55# |

Six casters - four 5" swivel (#C450) and two 2" x 6" rigid (#C518).

- Folds up for easy storage.
- Has 7-1/2 square feet of deck space... Takes up less than 2 square feet of storage space.
- For transporting heavy loads from the back room to the floor.
- Center rigid casters allow for zero turning radius.
- Lifetime warranty against rust and corrosion.



Low Boy Stock Cart



#1183

| Model No. | Size W-H-L | Wt. Cap. | Deck Ht. | No. Casters | Ship Wt. |
|-----------|-----------------|----------|----------|-------------|----------|
| 1183 | 16" x 41" x 54" | 1000# | 9-1/8" | 6 | 36# |
| 1184 | 14" x 40" x 39" | 1000# | 7-3/4" | 4 | 22# |

Model #1183: four 5" swivel (#C450) two 6" rigid (#C518) platform type casters.
 Model #1184: two 5" swivel (#C450) two rigid (#C460) platform type casters.

EACH UNIT HAS A REMOVABLE HANDLE.

- Designed for transporting heavy loads from the back room to the floor.
- Center rigid casters allow for zero turning radius.
- Rounded front helps protect walls and displays.
- Lifetime warranty against rust and corrosion.



Folding Utility Cart

| Model No. | Size W-H-L | Position | Deck Size | Wt. Cap. | Ship Wt. |
|-----------|---------------------|----------|-----------|----------|----------|
| 96856 | 16" x 64" x 64-3/4" | Unfolded | 16" x 60" | 1500# | 74# |
| | 16" x 14" x 64-3/4" | Folded | | | |

Four 5" x 1-1/4" polyurethane, platform type swivel casters (#C450) and two 6" x 2" polyurethane, platform type rigid casters (#C518).

Units Without Casters

| | | | | | |
|---------|---------------------|--------|-----------|-------|-----|
| 96856NC | 16" x 14" x 64-3/4" | Folded | 16" x 60" | 1200# | 51# |
|---------|---------------------|--------|-----------|-------|-----|

OPTIONS: *** FACTORY INSTALLED ONLY***

"E" - See page 63 for details

- **Effortless Stocking Capability**
 - Ideal for transporting heavy loads from the back room to the floor area or cooler.
 - Big enough to stock a complete area with one trip!
- **Completely Portable** - Six wheel design allows the unit to turn on a dime.
- **Guaranteed Maintenance Free**
 - **Lifetime Guarantee** against rust and corrosion.
 - **Five-Year Construction Guarantee.**
- **Maximum Storage Space**
 - Stores upright (on-end) to maximize available storage space.



#96856



U-Boat

| Model No | Size W-H-L | Wt. Cap. | Ship Wt. |
|----------------|---------------------|----------|----------|
| U-BOATS | | | |
| 95762 | 18" x 52-1/4" x 60" | 1500# | 51# |
| 96055 | 20" x 52-1/4" x 60" | 1500# | 59# |

Units equipped with four 5" x 1-1/4" polyurethane, platform type swivel 'end' casters (#C450) and two 6" x 2" polyurethane, platform type rigid 'center' casters (#C518).

REMOVABLE SHELVES FOR U-BOATS

| | | |
|---------|------------|-----|
| 95762RS | For #95762 | 13# |
| 96055RS | For #96055 | 15# |

Removable shelves are reinforced with a solid cover.

Options:

"E" - See page 63 for details

- **Traditional Six-Wheel Design.**
 - Four swivel and two center rigid casters allow these carts to rotate in their own length.
 - Big enough to stock a complete area with one trip!
- **Ideal For Narrow, Busy Aisles.**
 - Approximately half the weight of common steel U-Boats.
- **Guaranteed Maintenance Free.**
 - **Lifetime Guarantee** against rust and corrosion.
 - **Five-Year Construction Guarantee.**
 - No Galvanization or paint to wear off.
- **Optional Removable Shelves Help Organize Product.**



#96055



#95762 With #95762RS



Bulk Delivery Truck

You Tube > <http://www.youtube.com/user/NewAgeInd#p/u/8/9ifh6PsCQdc>

| Model No. | Size W-H-L | Position | Wt. Cap. | Ship Wt. |
|---|-----------------|----------|----------|----------|
| BDT18568 | 18" x 63" x 61" | Unfolded | 1200# | 104# |
| | 18" x 17" x 61" | Folded | | |
| Casters= six 8" x 2" casters; four swivel (#C526), two rigid (#C527). | | | | |
| BDT18566 | 18" x 61" x 61" | Unfolded | 1200# | 96# |
| | 18" x 15" x 61" | Folded | | |
| Casters= six 6" x 2" casters; four swivel (#C530), two rigid (#C531). | | | | |

Units Without Casters

| | | | | |
|------------|---------------------|--------|-------|-----|
| BDT18568NC | 18" x 12-3/4" x 61" | Folded | 1200# | 63# |
| BDT18566NC | 18" x 10-3/8" x 61" | Folded | 1200# | 52# |

Replacement Components

- 94293..... Removable Handle w/ plastic sleeve
- 94294..... Non-Removable Handle w/ plastic sleeve & pivot

Options:

Nylon Cover — Fits Above Units Only

Model #98172

Removable Handle — Add "R" suffix to model #.

Rigid Brake (1) — Add "B" suffix to model #.



Optional Rigid Brake

- Solid integrated deck.
- Center rigid casters allow for zero turning radius.
- Most durable Beverage Delivery Truck on the market.
- Stores on-end for space savings!
- Lifetime warranty against rust and corrosion.



#BDT18566



#BDT18568



#98172
Optional Nylon Cover

"Don't Compromise....Customize."



#50009



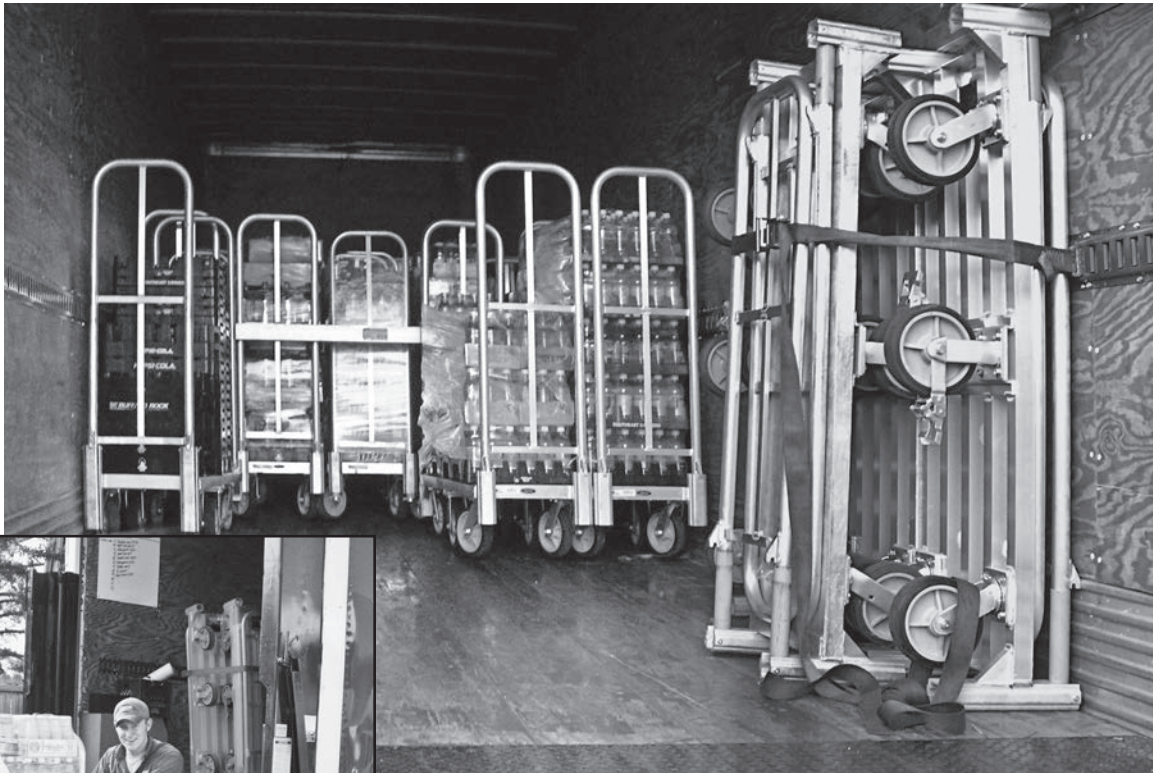

- Maneuverable — zero turning — easier for narrow aisles and coolers.
- Time savings — no off loading or extra handling.
- Reduce injuries from extra handling.
- Easier checking in visible product.
- Less time in the store and reduces store congestion.
- Reduce service time—full access to all sides.

- Big enough to transport enough product to stock a complete area, this folding delivery truck allows quick, convenient stocking.
- Vertical cart storage allows 100% accessibility for your next delivery.

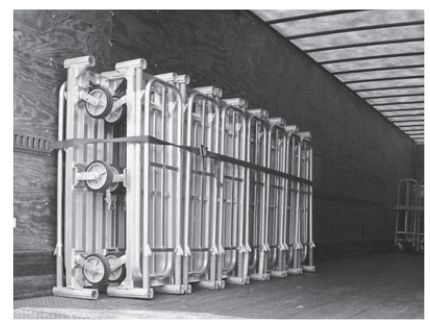

Box Truck



#1152

| Model No | Size W-H-D | No. Of Shelves | Ship Wt. |
|-----------|-----------------|----------------|----------|
| 1151..... | 27" x 71" x 63" | 2..... | 74# |
| 1152..... | 27" x 71" x 63" | 3..... | 85# |

Four 6" platform type casters: two swivel w/ brake (#C511) and two rigid (#C518).

OPTIONS:

"B", "PB", "& "VB" -- see page 63 for details.

- Transport heavy loads up to 2600#.
- Heavy Duty 6" platform type casters.
- All welded, heavy duty aluminum construction.
- Lifetime warranty against rust and corrosion.



Uni-T Truck



#1430

| Model No | Size D-H-L | Wheel Size | Ship Wt. |
|-----------|-----------------|------------|----------|
| 1430..... | 24" x 68" x 58" | 6"..... | 76# |
| 1431..... | 24" x 70" x 58" | 8"..... | 82# |

Model #1430: Four 6" x 2" casters, two swivel (#C490), two rigid (#C500).
Model #1431: Four 8" x 2" casters, two swivel (#C526), two rigid (#C527).

OPTIONS:

"B", "PB", "& "VB" -- see page 63 for details.

- Transport heavy loads up to 2000#.
- All welded, heavy duty aluminum construction.
- Lifetime warranty against rust and corrosion.



"Don't Compromise....Customize."



#98593



#99240



#98297



HD Multi-Shelf Truck - All Aluminum

| Model No. | Size D-H-L | Wt. Cap. | No. Shelves | Shelf Spacing | Ship Wt. |
|-----------|----------------------|----------|-------------|---------------|----------|
| 1450..... | 29" x 66" x 62"..... | 3000# | 5 | 12" | 147# |
| 1451..... | 29" x 66" x 75"..... | 2500# | 5 | 12" | 180# |
| 1452..... | 29" x 66" x 62"..... | 2500# | 4 | 16-1/2" | 135# |
| 1455..... | 29" x 66" x 62"..... | 3000# | 6 | 9-1/4" | 156# |

Four 8" platform type casters— two swivel (#C526) two rigid (#C527).
Each Unit Is Equipped With A Full Perimeter Bumper.

OPTIONS:

Towing Options Available — Call For Pricing

- Built for transporting BIG loads.
- Smooth radius handle and uprights.
- Solid shelves with marine edges add strength and contain spills.
- Standard perimeter bumper protects surfaces.
- Durable, all welded aluminum construction with 8" x 2" casters (standard).
- Lifetime warranty against rust and corrosion.



#1452



HD Multi-Shelf Truck - Stainless Steel Shelves

| Model No. | Size D-H-L | Wt. Cap. | No. Shelves | Shelf Spacing | Ship Wt. |
|------------|--------------------------|----------|-------------|---------------|----------|
| 97942..... | 29" x 66" x 65-1/2"..... | 3000# | 5 | 10-1/2" | 270# |
| 98181..... | 29" x 66" x 76-1/2"..... | 2500# | 5 | 10-1/2" | 315# |
| 98182..... | 29" x 66" x 65-1/2"..... | 2500# | 4 | 14-1/2" | 230# |
| 98183..... | 29" x 66" x 65-1/2"..... | 3000# | 6 | 8-1/4" | 315# |

Four 8" platform type casters— two swivel (#C526) two rigid (#C527).
Each Unit Is Equipped With A Full Perimeter Bumper.

OPTIONS:

Towing Options Available — Call For Pricing

- Built for transporting BIG loads.
- Durable, all welded aluminum frame with removable stainless steel shelf covers.
- Smooth radius handle and uprights.
- Standard perimeter bumper protects surfaces.
- Equipped with 8" x 2" casters (standard).
- Lifetime warranty against rust and corrosion.



#97942



"Don't Compromise...Customize."



#99361



#97852



#50171



#99012



Extreme Duty Utility Truck



#97180

| Model No | Size W-H-D | Shelf Size | Ship Wt. |
|------------|-----------------|-------------------|----------|
| 97177..... | 22" x 41" x 37" | 21-3/4" x 33-5/8" | 69# |
| 97178..... | 22" x 41" x 54" | 21-3/4" x 50-5/8" | 82# |
| 97179..... | 29" x 41" x 37" | 28-3/4" x 33-5/8" | 74# |
| 97180..... | 29" x 41" x 54" | 28-3/4" x 50-5/8" | 89# |

Two Tier Units With 27" Between Shelf Clearance.

Four 6" heavy duty polyurethane platform type casters: two swivel (#C510) and two rigid (#C518).

OPTIONS:

"B", "CL(C)", "PB", "PP(A)", "VB" — see page 63.

- Two-Tier units, shelves have three lips up to contain product.
- Transport heavy loads up to **1500# per shelf**
— **2000# Rolling Capacity** —
- Heavy Duty 6" platform type casters.
- All welded, heavy duty aluminum construction.
- Lifetime warranty against rust and corrosion.



Heavy Duty Utility Cart



97769

| Model No. | Size W-H-D | Shelf Size | Shelf Spacing | Wt. Cap. | Ship Wt. |
|------------|---------------------|-----------------|---------------|----------|----------|
| 97769..... | 18-1/2"x39"x32-1/2" | 18-1/2"x28-3/4" | 14-1/2" | 550# | 45# |

Four 5" plate type casters - two swivel (#C450) two rigid (#C460) with tamper proof fasteners.

Three tier solid shelf unit: each shelf with three sides up 1-1/4" and one side down 1-1/4".

OPTIONS:

"B", "CL(B)", "PB", "VB" — see page 63 for details.

- Ideal three shelf unit , shelves have three lips up to contain product.
- Strength and durability of stainless steel at much less the cost.
- Lifetime warranty against rust and corrosion.



"Don't Compromise...Customize."



#99238



#99211



#99108



#98765



Utility Cart

| Model No. | Size W-H-D | Shelf Size | Shelf Spacing | Wt. Cap. | Ship Wt. |
|-----------|-------------------------|-------------------|---------------|----------|----------|
| NS745 | 18-1/2" x 39" x 32-1/2" | 18-1/2" x 28-3/4" | 13" | 350# | 38# |
| 1440 | 16-1/2" x 39" x 27-3/4" | 16-1/2" x 24" | 13" | 350# | 36# |

Four 5" stem type casters— two swivel (#C480) two w/ brake (#C485).

Two tier solid shelf unit: each shelf with three sides up 1-1/4" and one side down 1-1/4".

OPTIONS:

"B", "MD", "VB" — see page 63 for details.

- Ideal three shelf unit , shelves have three lips up to contain product.
- Strength and durability of stainless steel at much less the cost.
- Lifetime warranty against rust and corrosion.



#NS745



Heavy Duty Stock Truck

| Model No | Size W-H-L | Wt. Cap. | Top Shelf Type | Top Shelf Height | Ship Wt. |
|----------|---------------------|----------|----------------|------------------|----------|
| NS557 | 21" x 44" x 59-1/2" | 3000# | Bar | 30" | 63# |

Unit With Solid Aluminum Top

| | | | | | |
|--------|---------------------|-------|-------|-----|-----|
| NS557A | 21" x 44" x 59-1/2" | 3000# | Solid | 30" | 65# |
|--------|---------------------|-------|-------|-----|-----|

Two tier unit with handle.

Four 6"x 2" platform type casters: two swivel w/ brake (#C495), two rigid (#C500).

OPTIONS:

"B", "PB", "VB" -- See page 63 for details.

- For use in any application that requires maximum strength and durability.
- All welded aluminum construction with four, 6" x 2" platform type casters.
- 3000# Weight capacity
- Lifetime warranty against rust and corrosion.



#NS557A



"Don't Compromise...Customize."



#99885



#99804

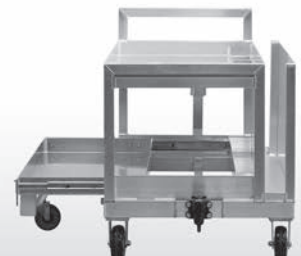

#99715



Ergonomic Mobile Work Station



Storage



Transport



30° Angle



45° Angle

#1407

| Model No. | Position | Size L-H-W | Wt. Cap. | Ship Wt. |
|-----------|-------------------|---------------------|----------|----------|
| 1407..... | Upright / Display | 43" x 43-1/2" x 24" | 1000# | 45# |
| | Flat / Storage | 48" x 19" x 24" | | |

Four heavy duty Polyurethane type platform casters — two: 2" x 5" rigid w/ brake (#C464) & two: 1-3/8" x 5" swivel (#C450).

- Slanted workstation for easy mobile access and product visibility.
- Ergonomic Tilt Cart.
- Vertical adjustment from flat, to 30° to 45° degrees providing three different views.
- Folds flat and stores upright to save space.
- Has 8 square feet of area... Takes up 3-1/2 square feet of storage space.
- Lifetime warranty against rust and corrosion.



Floral Cart



#NS765

| Model No. | Size W-H-L | Top Shelf Height | Shelf Size | Ship Wt. |
|-------------|---------------------|------------------|-------------------|----------|
| NS765 | 18-5/8" x 32" x 45" | 32" | 17-1/2" x 40-1/2" | 43# |

Two tier unit. Each solid shelf has 1-1/2" lip on all sides (will hold water). **HANDLE AND VERTICAL CORNER BUMPERS ARE STANDARD.** Four 5" platform type swivel casters (#C453).

- Each shelf has a 1-1/2" lip perimeter to hold spills.
- All welded aluminum construction with 5" platform casters.
- Weight Capacity = 500#
- Lifetime warranty against rust and corrosion.

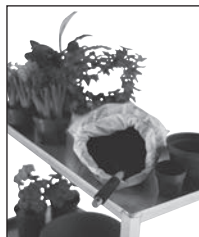

Spill Containing Shelves



Wet Product Cart

| Model No | Size W-H-L | Wt. Cap. | No. Casters | Top Shelf Height | Ship Wt. |
|--|---------------------|----------|-------------|------------------|----------|
| CARTS W/ TWO (2) REMOVABLE PANS | | | | | |
| 1408..... | 21" x 41" x 48-1/2" | 1200# | 6 | 30" | 64# |
| 1410..... | 29" x 41" x 50-1/2" | 1000# | 6 | 30" | 73# |

Above units come equipped with a full perimeter bumper on the top shelf. Six 5" platform type casters — four swivel (#C450) two rigid (#C460).

Options:

"CL(B)" — See page 63 for details.

Rear Mount Basket - Add "RMB" suffix to model #.

Paper Towel Bracket - Add "PTB" suffix to model #.

- This Wet Product Truck helps minimize the mess of transporting product by retaining moisture and debris.
- **With two reinforced removable drip pans, this unit allows you to contain as well as remove unwanted moisture promoting a clean, sanitary area.**
- Each removable shelf is reinforced with a heavy-duty, channel-enforced frame supported by four sturdy posts (one located at each corner).



#1408 • #1410



Wet Product Cart

| Model No | Size W-H-L | Wt. Cap. | No. Casters | Top Shelf Height | Ship Wt. |
|--------------------------------------|---------------------|----------|-------------|------------------|----------|
| CART W/ ONE (1) REMOVABLE PAN | | | | | |
| 97126.... | 24-3/8" x 38" x 52" | 700# | 4 | 30" | 48# |

Above unit has removable pan on top shelf w/ heavy duty tubular base. Four 5" platform type casters — two swivel (#C450) two rigid (#C460).

Options:

"CL(B)", "PB" -- See page 63 for details.

Paper Towel Bracket - Add "PTB" suffix to model #.

- Double-deck cart moves product at a convenient, workable height from the floor.
- Perfect for narrow aisles with a width of 24-3/8".
- All-welded construction provides for heavy duty stocking operations.
- Removable shelf tray contains spills.



#97126



Tubular Deck Cart



#95661

| Model No | Size W-H-L | Wt. Cap. | Top Shelf Height | Shelf Spacing | Ship Wt. |
|----------|-----------------|----------|------------------|---------------|----------|
| 95661 | 19" x 42" x 46" | 700# | 30" | 20-5/8" | 35# |

Four 5" platform type casters, two swivel (#C450) two rigid (#C460).

Options:

"CL(B)" — See page 63 for details.

- Double-deck cart moves product at a convenient, workable height from the floor.
- Perfect for narrow aisles with a width of 19".
- All-welded construction provides for heavy duty stocking operations.



Utility Stock Truck



#96134BH

| Model No | Size W-H-L | Wt. Cap. | Top Shelf Height | Shelf Spacing | Ship Wt. |
|----------|---------------------|----------|------------------|---------------|----------|
| 96134BH | 19" x 41-1/2" x 46" | 700# | 30" | 19-3/4" | 42# |

Four 5" platform type swivel casters (#C453).
Handle and Corner Bumpers — Standard Equipment.

- Double-deck stock truck moves product at a convenient, workable height from the floor.
- Perfect for narrow aisles with a width of 19".
- All-welded construction provides for heavy duty stocking and produce operations.



"Don't Compromise....Customize."



#97180



#96803



#96076



#96134



#97594



Picking Cart

| Model No | Size W-H-L | Wt. Cap. | No. Casters | Top Shelf Height | Ship Wt. |
|---|-----------------|----------|-------------|------------------|----------|
| SOLID TOP SHELF • T-BAR BOTTOM SHELF | | | | | |
| 1415..... | 19" x 30" x 41" | 800# | 4 | 30" | 43# |
| SOLID TOP SHELF • T-BAR BOTTOM SHELF W/ HANDLE | | | | | |
| 1416..... | 19" x 39" x 48" | 800# | 4 | 30" | 52# |
| T-BAR TOP & BOTTOM SHELF W/ HANDLE | | | | | |
| 1420..... | 19" x 39" x 48" | 1200# | 4 | 30" | 52# |
| SOLID TOP & BOTTOM SHELF W/ HANDLE | | | | | |
| 1490..... | 19" x 39" x 48" | 800# | 6 | 30" | 55# |

Model #1415, #1416 & #1420: Four 5" platform type casters - two swivel (#C450) two rigid (#C460).
Model #1490: Six 5" platform type casters - four swivel (#C450) two rigid (#C460).

OPTIONS: * FACTORY INSTALLED ONLY*****

"CL(B)", "PB" — See page 63 for details.

- These all welded units provide maximum strength and durability.
- Raised marine edge on solid shelves contain spills.
- T-Bar type shelves provide air circulation.
- Lifetime warranty against rust and corrosion.



#1415



#1420



#1490

Picking Carts

| Model No. | Size W-H-D | Ship Wt. |
|------------|---------------------|----------|
| 98012..... | 48" x 42-1/2" x 22" | 65# |

Equipped with four 5" platform type swivel casters (#C450).

- Three shelf cart designed for small part order picking, with three side bars for containment.
- Steel document shelf allows you to use magnets to hold picking sheets and other documents in place.
- Lifetime warranty against rust and corrosion.
- Can be custom built to fit your individual picking needs.



#98012

"Don't Compromise...Customize."



#98639



#98601



#98559



#99501PC



Picking Cart



| Model No. | Size W-H-D | Ship Wt |
|------------|---------------------|---------|
| 97986..... | 70" x 81" x 21-3/4" | 86# |

Equipped with two 5" swivel (#C450) two rigid (#C460) platform type casters.

- Designed for transporting heavy loads.
- Steel document shelf allows you to use magnets to hold picking sheets and other documents in place.
- Top shelf is designed with a tube back stop for added safety.
- Lifetime warranty against rust and corrosion.
- Can be custom built to fit your individual picking needs.

#97986



3-Tier Picking Cart



| Model No | Size W-H-D | Shelf Size | Shelf Clearance | Ship Wt. |
|------------|---------------------|---------------|-----------------|----------|
| 97476..... | 59" x 67-1/2" x 26" | 24-1/2" x 56" | 20" | 101# |

Four 5" platform type casters: two swivel (#C450), two rigid (#C460).

OPTIONS:

"B", "CL(B)", "PB", "VB" — See page 63 for details.

- All welded, heavy duty aluminum construction.
- Each shelf set at 20° angle for easy product selection.
- See page 31 for lugs.

#97476



"Don't Compromise....Customize." – Trolley Carts



#99804



#98423





#97476
The "Original"

#99171
Change shelf angle.
Add center pivot caster.



#99726
Add storage tray.



#99538
Add a document shelf.



#99249
Add a handle, storage tray, & make it double sided.



#99470
Add a tow hook.



#99377
Add a step and pull out shelf.

Little changes don't have to cost **BIG MONEY.**

At New Age, we know what a big difference little changes can make. That's why we pride ourselves on customer-friendly customizing. We control the manufacturing process from start-to-finish, thus controlling the cost.

Whether you want to accommodate a specific box or tote, make a unit wider, narrower, shorter, taller, etc... we have the capability to deliver it in a fast, economical fashion.

EVOLUTION



Picking Tote Carts



#99799

| Model No. | Size W-H-L | Wt. Cap. | Shelf Spacing | Ship Wt. |
|-----------|-------------------------|----------|---------------|----------|
| 99799 | 23-3/8" x 51" x 60-3/8" | 800# | 16" | 130# |

Four 5" platform type swivel casters - (#C450).

- T-Bar, easy-load, heavy duty cart.
- Equipped with ergonomic "soft grip" handles and an elevated base shelf.
- Extended base frame clears box debris in shipping and packaging areas.
- Lifetime warranty against rust and corrosion.



#99867

| Model No. | Size W-H-L | Wt. Cap. | Shelf Spacing | Ship Wt. |
|-----------|-----------------------------|----------|---------------|----------|
| 99867 | 20-1/2" x 72-3/4" x 79-1/4" | 800# | 19-7/8" / 14" | 285# |

Six 5" platform casters - four swivel (#C450), two rigid (#C460).

- T-Bar, easy-load, heavy duty cart.
- Equipped with ergonomic handles and ladder holder on opposite ends.
- Zero turning radius, center pivoting, six caster design.
- Horizontal end cross pieces secure product during transport and storage.
- Lifetime warranty against rust and corrosion.



"Don't Compromise....Customize."



#98525



#99038



"Test Drive" A Picking Cart

"No Cost" Solution to Pick & Put
You only pay the freight both ways!

| Model No. | Size W-H-L | Wt. Cap. | Shelf Spacing | Ship Wt. |
|------------|-----------------------|-----------|-----------------|----------|
| 50212..... | 24" x 47" x 63" | 800#..... | Adjustable..... | 125# |

Six 5" platform casters - four swivel (#C461), two rigid (#C463).

- "K.D" ships knocked down
- Shelves adjust to fit your needs.
- Adjustable handle.
- Six caster design = Zero turning radius.



#50212

• Call For Details •



"Build Your Own" Mobile Picking Cart

Custom Picking Carts
 Designed by YOU
 Built by YOU
 Using stock component parts.

- Adjustable all welded aluminum shelves.
- Base unit is all welded.
 - Plate type casters.
 - 4 or 6 wheels.
- **Shelving**
 - H.D. Style pg. 45
 - T-Bar Style pg. 46
 - Solid Style pg. 47
- **Posts** pg. 49
- Lifetime Guarantee against rust and corrosion.

#50313
 Handle/Desk w/ Tray
 (fits 24"D shelf only)



#50314
 1-1/2" Tube Handle
 (fits 24"D shelf only)



#50316
 Document Tray
 4"D x 4"H x 16.1/2"L
 (fits 24"D shelf only)



#50315
 Trash Can w/ Hanger
 (fits 24"D shelf only)



#50311X6 Base



#50311

| Model No. | Size D-H-L | Wt. Cap. | Ship Wt. |
|------------|--------------------------|------------|----------|
| 50310..... | 24" x 9-3/8" x 36" | 800# | 22# |
| 50311..... | 24" x 9-3/8" x 48" | 800# | 28# |
| 50312..... | 24" x 9-3/8" x 60" | 800# | 34# |

Four 5" platform casters - two swivel (#C455), two rigid (#C460).

Options:

SIX WHEEL - ZERO TURNING — Add "X6" suffix to model #.
 - Six 5" platform casters - four swivel (#C455), two rigid (#C460).



Open Cage Truck



#97132

| Model No. | Size W-H-D | Deck Size | Ship Wt. |
|------------|------------------------|----------------|----------|
| 97132..... | 56-¼" x 58" x 22"..... | 21" x 48"..... | 75# |
| 97592..... | 56-¼" x 58" x 30"..... | 29" x 48"..... | 85# |

Four 6" x 2" platform type casters — two swivel (#C510), two rigid (#C518).

- Specifically designed for oversized loads
- Whatever the load, large or small, this truck is equipped to handle your needs.
- With solid aluminum base and 43" high sides enclosing three sides, even large loads can be safely contained



Carrier Cart



#95667

| Model No. | Size W-H-L | Shelf Size | No. Shelves | Ship Wt. |
|------------|------------------------|----------------|-------------|----------|
| 95667..... | 20-½" x 55" x 64"..... | 20" x 60"..... | 3..... | 100# |

Four 6" x 2" platform type casters — two swivel (#C510), two swivel w/ brake (#C511).
Note: Handles (4) Add 3-½" To The Length Of The Unit.

- Multipurpose cart for the storage and transport of modules, boxes, buckets, and similar items.
- Heavy duty all welded construction.
- All three solid shelves have three edges turned up (sides & back), with the front edge turned down.
- Upper two shelves are slanted 1° toward the rear to facilitate drainage.
 - All shelves have drainage holes
- Equipped with four heavy duty 6" x 2" platform type swivel casters, two with brakes.
- **Shelf clearance = 17-½"** • **Weight Capacity = 1800#**
- Lifetime warranty against rust and corrosion.



"Don't Compromise....Customize."



#98243



#98891



#95948



#99212



Hopper Bottom Bins "I.B.C."

Intermediate Bulk Container

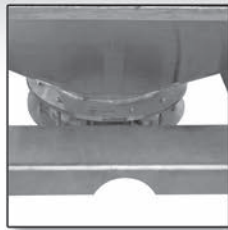
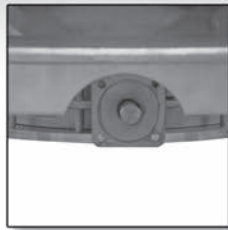

- Designed to hold, blend and dispense raw materials or provide bulk storage for finished goods.
- Four-way fork pockets allow entry from all sides.
- Used for dry flowables, powders or viscous liquid.
- All welded, lightweight aluminum construction.
- Valve operation can be via:
 - Fixed handle, removable handle, remotely controlled pneumatic activator or fully integrated controlled.
- Butterfly valves available in 8", 10" or 12" sizes.
- Shown with 45° Hopper Bin base, units with a 60° base are also available.
- Lid shown is reinforced and has a 3" fusible top vent.
 - Optional lids include; flat, reinforced or one can be customized to fit your needs.
- United Nations certification is available for transporting hazardous materials.
- These bins are made on a custom order bases, please contact us for information and pricing.



Forklift Order Picking Carts



#98852

- All welded heavy duty aluminum construction.
- Forklift Order Picker secures to order picker cage with 2" x 4" wood block.
- Adjustable shelving with aluminum amplimesh sides. - 4° shelf slope.
- Organize and secures product.
- Mobile design allows safe and efficient moving.
- Universal forklift pockets.

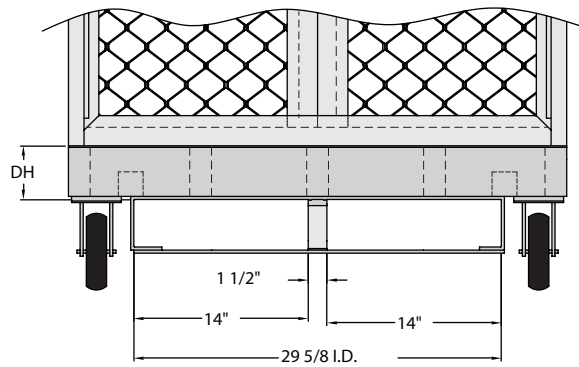

#99418



| Model No. | Lift Type | Size W-H-D | DH | Ship Wt. |
|--|-------------|---------------------|---------|----------|
| THREE ADJUSTABLE SHELVES • 24"D x 36-3/4"W • ADJUSTABLE ON 4" CENTERS | | | | |
| 98852C | Crown/Clark | 40" x 89" x 48" | 5-1/4" | 350# |
| 98852H | Hyster | 40" x 89-1/2" x 48" | 6-1/16" | 350# |
| 98852R | Raymond | 40" x 88" x 48" | 4-3/8" | 350# |
| 98852T | Toyota | 40" x 88" x 48" | 4-3/8" | 350# |
| TWO ADJUSTABLE SHELVES • 32"D x 36-3/4"W • ADJUSTABLE ON 4" CENTERS | | | | |
| 99418C | Crown/Clark | 40" x 89" x 48" | 5-1/4" | 350# |
| 99418H | Hyster | 40" x 89-1/2" x 48" | 6-1/16" | 350# |
| 99418R | Raymond | 40" x 88" x 48" | 4-3/8" | 350# |
| 99418T | Toyota | 40" x 88" x 48" | 4-3/8" | 350# |

Equipped with four 6" platform type casters; two rigid (#C518), two swivel with brake (#C511). "DH" is the measurement from the top of the fork to the top of the deck. Custom Sizes Available.



"Don't Compromise....Customize."



#99162



#99998



#99567



Forklift Order Picking Carts

- All welded heavy duty aluminum construction.
- Forklift Order Picker secures to order picker cage with 2" x 4" wood block.
- Adjustable shelving with aluminum amplimesh sides.
 - 4° shelf slope.
- Organize and secures product.
- Mobile design allows safe and efficient moving.
- Universal forklift pockets.

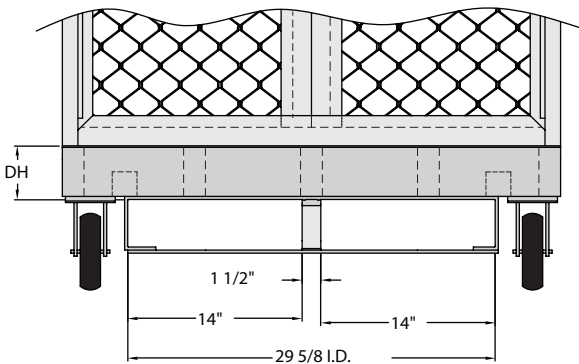

#99664



#99664S30

| Model No. | Lift Type | Size W-H-D | DH | Ship Wt. |
|--|-------------|------------------------|---------|----------|
| FORKLIFT PICKING CARTS - EQUIPPED WITH TWO 30" DEEP SHELVES | | | | |
| 99664C | Crown/Clark | 40" x 77" x 48" | 5-1/4" | 410# |
| 99664H | Hyster | 40" x 78" x 48" | 6-1/16" | 410# |
| 99664R | Raymond | 40" x 76" x 48" | 4-3/8" | 410# |
| 99664T | Toyota | 40" x 76" x 48" | 4-3/8" | 410# |
| ADDITIONAL SHELVES - SHELVES ARE EQUIPPED WITH 3 STRIPS OF ANTI-SLIP TAPE | | | | |
| 99664S15 | | 36-3/4" x 1-1/2" x 15" | | 15# |
| 99664S30 | | 36-3/4" x 1-1/2" x 30" | | 30# |

Four 6" platform type casters; two rigid (#C518), two swivel with brake (#C511).
 "DH" is the measurement from the top of the fork to the top of the deck.
 Custom Sizes Available.

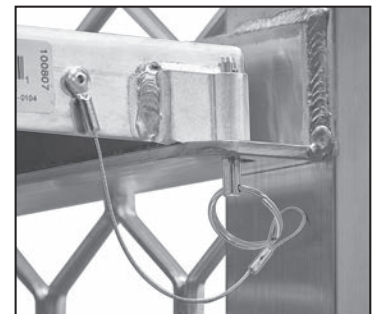

Shelves Secure To Angle Glides



"Don't Compromise...Customize."



#99739



#98909



Channel Pallets

You Tube > http://www.youtube.com/user/NewAgeInd#p/u/3/6QsLFJS_oho



#99557

| Model No. | Size W-H-D | Entry Type | Ship Wt. |
|-----------|----------------|------------|----------|
| 99557 | 40" x 5" x 48" | 2-Way | 52# |
| 99387 | 40" x 5" x 48" | 4-Way | 51# |

Custom Sizes Available

- All-welded construction.
 - Fireproof
 - Recyclable
 - Metal Detectable
- Heavy 6005 T-6 Type Aluminum.
- Stackable/Nestable.
- FDA Approved with open channels for easy cleaning.
- Lifetime Guarantee against rust and corrosion.

LOAD WEIGHTS

STATIC= 30,000 LBS
 DYNAMIC= 5,000 LBS
 RACKABLE= 5,000 LBS
 TRUCKLOAD= 510 PER T/L
 ALUM WEIGHT= 50LBS



Tube Frame Pallets

You Tube > http://www.youtube.com/user/NewAgeInd#p/u/3/6QsLFJS_oho



#99613

| Model No. | Size W-H-D | Ship Wt. |
|-----------|--------------------|----------|
| 99613* | 40" x 5-1/4" x 48" | 51# |
| 99749 | 40" x 5-1/4" x 48" | 48# |

* Equipped with center base tube as shown.
 Custom Sizes Available

- All-welded construction.
 - Fireproof
 - Recyclable
 - Metal Detectable
- Sealed tube, all welded frame construction
- Four-way pallets.
- Lifetime Guarantee against rust and corrosion.

LOAD WEIGHTS

STATIC= 30,000 LBS
 DYNAMIC= 5,000 LBS
 RACKABLE= 5,000 LBS
 TRUCKLOAD= 510 PER T/L
 ALUM WEIGHT= 50LBS



Forklift Picking Platform

| Model No. | Lift Type | Size W-H-D | DH | X | XX | Ship Wt. |
|-----------|-----------|----------------------|---------|---------|---------|----------|
| PPR4048 | Raymond | 40" x 9-1/2" x 48" | 4-3/8" | 18-1/2" | 29-1/2" | 115# |
| PPH4048 | Hyster | 40" x 11-3/16" x 48" | 6-1/16" | 17" | 28" | 120# |
| PPC4048 | Crown | 40" x 10-3/8" x 48" | 5-1/4" | 15" | 26" | 120# |
| PPT4048 | Toyota | 40" x 9-1/2" x 48" | 4-3/8" | 18-1/2" | 29-1/2" | 115# |

"DH" is the measurement from the top of the fork to the top of the deck.
Custom Sizes Available.

- Forklift Order Picker secures to order picker cage with 2" x 4" wood block.
- Fork pockets are 4" x 6" x 1/4" wall tube.
- Replaceable wood clamp block.
- Anti-slip tape on end.
- Heavy duty aluminum construction.
- Lightweight and durable.
- Lifetime Guarantee against rust and corrosion.

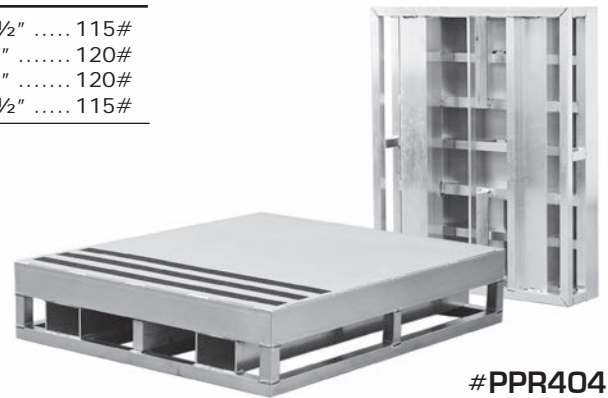

#PPR4048

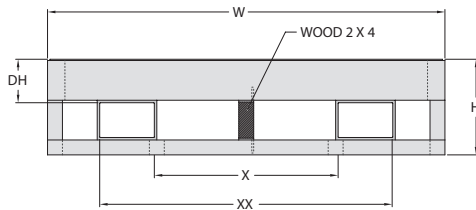

Raised Platform Picking Pallet

| Model No. | Lift Type | Size W-H-D | X | XX | Ship Wt. |
|-----------|-----------|---------------------|---------|---------|----------|
| 99566 | Raymond | 45" x 36" x 43-1/2" | 18-1/2" | 29-1/2" | 165# |

Custom Sizes Available.

- Ergonomic raised platforms for easier loading and unloading.
- Forklift Order Picker secures to order picker cage with 2" x 4" wood block.
- Fork pockets are 4" x 6" x 1/4" wall tube.
- Replaceable wood clamp block.
- Heavy duty aluminum construction.
- Lightweight and durable.
- Custom sizes available.
- Lifetime Guarantee against rust and corrosion.

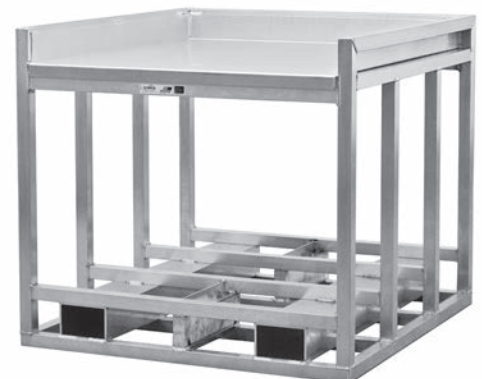

#99566

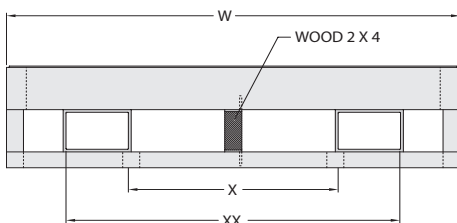

"Don't Compromise...Customize."



#50263



#50238



#50264



Ladder Carts



#99640

| Model No | Size W-H-L | No. Of Shelves | Top Shelf Height | Shelf Spacing | Wt. Cap. | Ship Wt. |
|----------|-------------------------|----------------|------------------|---------------|----------|----------|
| 99640 | 22" x 69-1/2" x 51-1/2" | 2 | 38" | 21-3/4" | 800# | 113# |
| 99555 | 22" x 69-1/2" x 51-1/2" | 3 | 38" | 13-1/2" | 800# | 120# |

Four 5" platform type casters, two swivel (#C461) two rigid (#C463).

- Easy-Load flat top shelves
- * Extended push handle = Shin Saver!
- * Continuous grip handle for ascending and descending.
 - Extended reach bar on top.
- Extra wide steps are welded and bolted in place.
 - Fitted with non-slip tape for safety.
- * Spring loaded, full contact ladder stops.
- * All welded, tubular base frame.
- * Caster mounts are welded to the frame.
- Custom sizes available.
- Lifetime Guarantee against rust and corrosion.



#99555



Flat Top Shelves

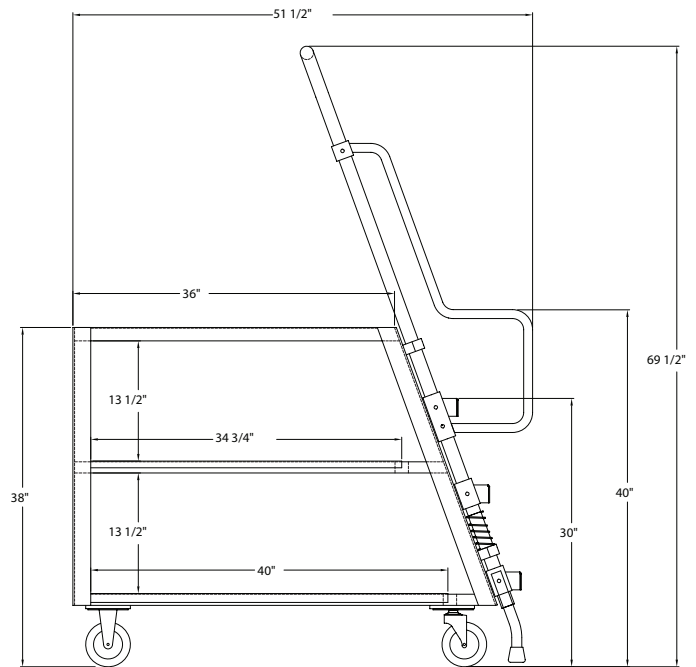

"Don't Compromise....Customize."



#96548



#99699



#50111



#99811



#99864



Ladder Carts

| Model No | Size W-H-L | No. Of Shelves | Top Shelf Height | Shelf Spacing | Wt. Cap. | Ship Wt. |
|----------|-------------------------|----------------|------------------|---------------|----------|----------|
| 50060 | 22" x 69-1/2" x 51-1/2" | 2 | 38" | 27-3/8" | 800# | 113# |
| 50061 | 22" x 69-1/2" x 51-1/2" | 3 | 38" | 12-9/16" | 800# | 120# |

Four 5" platform type casters, two swivel (#C461) two rigid (#C463).

- Shelf lips up on all sides to contain product.
- * Extended push handle = Shin Saver!
- * Continuous grip handle for ascending and descending.
 - Extended reach bar on top.
- Extra wide steps are welded and bolted in place.
 - Fitted with non-slip tape for safety.
- * Spring loaded, full contact ladder steps.
- * All welded, tubular base frame.
- * Caster mounts are welded to the frame.
- Custom sizes available.
- Lifetime Guarantee against rust and corrosion.



#50060

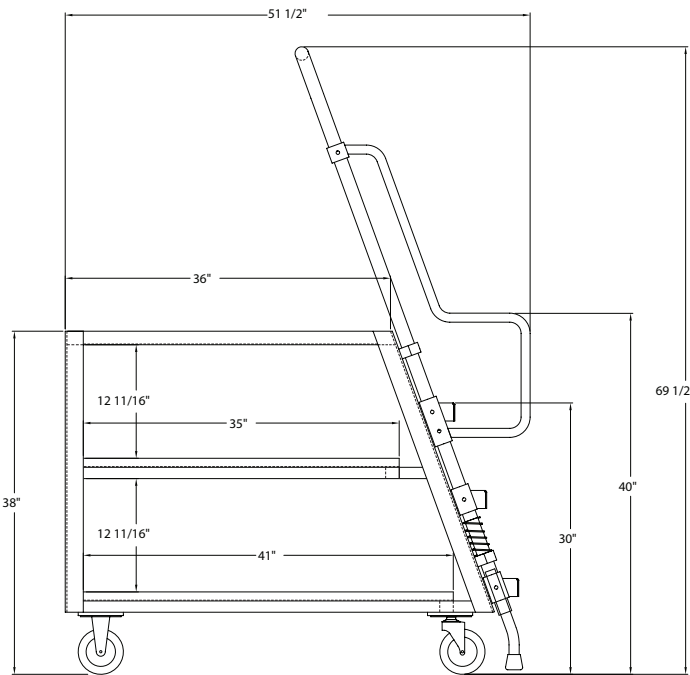

Shelf Lips Up



#50061



"Don't Compromise...Customize."



#50064



#99710



#99113



#99051



Lug (Tub) Carts - Plus Series

| Model No. | Size W-H-D | Lug Cap. | Ship Wt. |
|---|-------------------------|----------|----------|
| HEAVY DUTY - Accepts 16" x 8-1/2" x 25" Lug (Not Included) | | | |
| 99181..... | 18-3/4" x 23" x 26" | 1..... | 20# |
| 99182..... | 18-3/4" x 34-1/2" x 26" | 2..... | 23# |
| 99183..... | 18-3/4" x 46" x 26" | 3..... | 26# |
| 99184..... | 18-3/4" x 57-1/4" x 26" | 4..... | 32# |
| 99185..... | 18-3/4" x 68-5/8" x 26" | 5..... | 35# |

#99181, #99182, & #99183 have four 5 x 1-3/8" stem type swivel casters (#C482).
 #99184 & #99185 have four 5" platform type swivel casters (#C450).

OPTIONS:

CL(A) = #99181, #99182 & #99183,
CL(B) = #99184 & #99185— See page 63 for details

- Channel slides allow tub to extend beyond the half-way point and still be loaded.
- Designed for easy loading and unloading.
- Top frame holds standard lug tube on cross supports.
- All welded aluminum construction.



Lug (Tub) Carts

| Model No. | Lug Cap. | Size W-H-D | Ship Wt. |
|-------------|----------|-------------------------|----------|
| 6265..... | 1..... | 15-3/4" x 19" x 23-1/2" | 11.5# |
| 6266..... | 2..... | 15-3/4" x 33" x 28" | 16# |
| 99316..... | 2..... | 32-1/2" x 19-1/4" x 26" | 17# |
| 97205..... | 3..... | 18-3/4" x 42" x 26" | 23# |
| 6262..... | 4..... | 18-3/4" x 51" x 26" | 31# |
| 97253..... | 5..... | 18-3/4" x 61" x 26" | 31# |
| 6263..... | 6..... | 18-3/4" x 71" x 26" | 32# |
| 6263KD..... | 6..... | 18-3/4" x 71" x 26" | 33.5# |

Four 5" swivel type stem casters (#C480) - No brakes.
 "KD" indicates unit ships "Knocked Down".

OPTIONS:

"CL(A)" — See page63 for details.

- Accepts standard lugs (16"W x 8-1/2"H x 25"L).
- Ideal for transporting bulk products.



Lugs

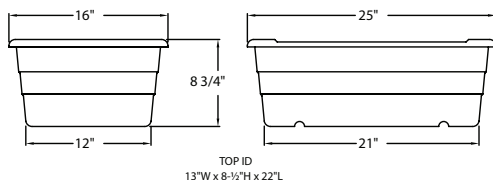

| Model No. | Size W-H-L | Color | Ship Wt. |
|---------------|--------------------|-------|----------|
| RGY16825..... | 16" x 8-1/2" x 25" | gray | 4# |
| 0361..... | Lid For #RGY 16825 | gray | 1# |

Food Approved Molded Poly • Formed Cross-Stacking Bottom



Heavy Duty Lug Carts

| Model No. | Size W-H-D | Lug Cap. | Ship Wt. |
|---|------------------------------|----------|----------|
| HEAVY DUTY - Accepts 16" x 8-1/2" x 25" Lug (Not Included) | | | |
| 1261..... | 18-3/4" x 27-1/2" x 21"..... | 2 | 23# |
| 1262..... | 18-3/4" x 52" x 26-1/2"..... | 4 | 33# |
| 1263..... | 18-3/4" x 72" x 26-1/2"..... | 6 | 41# |
| 93136*..... | 29-1/2" x 38" x 32-1/2"..... | 6 | 28# |
| 1264..... | 29-1/2" x 62" x 33"..... | 10..... | 48# |

MODEL #1261 REQUIRES STACKING LUGS
 #1261, #1262, & #1263 has four 5" plate type swivel casters (#C450).
 #1264 has four 5" platform type casters; two swivel with brake (#C465), two rigid (#C475).

OPTIONS:
 "CL(B)" (#1261, #1262 & #1263 only) — See page 63 for details.

| | | | |
|---|--------------------------------------|---------|-----|
| STANDARD - Accepts 16" x 8-1/2" x 25" Lug (Not Included) | | | |
| 1265..... | 15-3/4" x 19" x 26"..... | 1 | 11# |
| 1266..... | 15-3/4" x 33" x 28-1/4"..... | 2 | 14# |
| 1267..... | Handle for #1265 & #1266 (bolted on) | | |

| | | | |
|--------------------------------------|----------------------------------|---------|-----|
| STANDARD - With Welded Handle | | | |
| 1265H..... | 15-3/4" x 36-1/2" x 28 3/8"..... | 1 | 14# |
| 1266H..... | 15-3/4" x 36-1/2" x 30-1/2"..... | 2 | 18# |

Four 5" stem type casters (#C480).
 * Not NSF Approved

OPTIONS:
 "CL(A)", "MD" — See page 63 for details.



E-Z Load Lug/Pick Cart

| Model No. | Size W-H-D | Wt. Cap. | Ship Wt. |
|------------|------------------------------|------------|----------|
| 99304..... | 15-3/4" x 41-1/2" x 28"..... | 500# | 20# |

Four 5" stem type casters (#C480).

- Designed for easy loading and unloading.
- Top frame holds standard lug tube on cross supports.
- All welded aluminum construction.



#99304



Bulk Carts



#99271 #99272 #99273 #99274
 #0381 #0363 #0360 #0382
 #0381L #0363L #0360L #0382L



#0381L
 Shoe Box Type Lid

- The perfect "bulk" cart for every department.
- All welded construction.
- Lifetime warranty against rust and corrosion.



#99521
 #0300

| Model No. | Size W-H-D | Ship Wt. |
|-----------|------------|----------|
|-----------|------------|----------|

*** All Items Are Sold Separately ***

2-1/4 Bushel • 16.5 Gallon
 99521.....Dolly20-1/4" x 33" x 26-1/4".....26#
 0300.....Tub19-1/4" x 13-3/4" x 26".....7#

4 Bushel • 30 Gallon
 99271.....Dolly21" x 28-1/4" x 30-1/4".....20#
 0381.....Tub ... 21-1/4" x 15-3/4" x 32-3/4"12#
 0381L.....Lid22-1/2" x 2" x 34".....4#

6 Bushel • 41 Gallon
 99272.....Dolly22" x 25" x 29".....20#
 0363.....Tub23-1/4" x 20" x 32-1/4"13#
 0363L.....Lid24-1/2" x 2" x 33-1/2".....6#

8 Bushel • 57 Gallon
 99273.....Dolly23-1/4" x 24" x 34-1/2".....22#
 0360.....Tub24-1/2" x 23" x 36-1/4"23#
 0360L.....Lid25" x 2-1/2" x 37-1/2".....9#

9 Bushel • 66 Gallon
 99274.....Dolly27-1/2" x 25" x 38-1/4".....23#
 0382.....Tub29-1/2" x 19" x 41-1/2"25#
 0382L.....Lid29-1/2" x 2-1/2" x 41-1/2"10#

Four 5" stem type casters (#C482).
 NOTE: Carts with lugs installed are 36" high.

Options:
 "CL(A)" — See page 63 for details.

Freezer Trucks



#1271
 End Load

#1274
 Side Load
 (Double Deep)

| Model No. | Size W-H-D | Basket Cap. | Runner Spacing | Between Uprights | Ship Wt. |
|-----------|----------------------------------|-------------|----------------|------------------|----------|
| 1271..... | 20" x 61" x 29"..... | 7 | 7-3/4" | 17-1/2" | 49# |
| 1272..... | 20" x 68-5/8" x 29"..... | 8 | 7-3/4" | 17-1/2" | 55# |
| 1273..... | 20" x 76-3/8" x 29"..... | 9 | 7-3/4" | 17-1/2" | 59# |
| 1274..... | 31-1/2" x 61-3/8" x 35-1/2"..... | 12 | 9" | 29" | 55# |

Designed to hold 17"W x 28"L wire freezer baskets and boxes.
 Four 5" platform type casters - 2 swivel (#C450), 2 rigid (#C460).

- 3-1/4" angle guides support baskets and boxes.
- Lifetime warranty against rust and corrosion.



Universal Lug Cart



#1279

| Model No. | Size W-H-D | Lug Capacity | Between Shelf Space | Ship Wt. |
|-----------|--------------------------|--------------|---------------------|----------|
| 1276..... | 18-1/2" x 36" x 26"..... | 3 | 10" | 26# |
| 1277..... | 18-1/2" x 47" x 26"..... | 4 | 10" | 28# |
| 1279..... | 18-1/2" x 68" x 26"..... | 6 | 10" | 35# |

Four 5" stem type casters (#C480).

OPTIONS:
 "CL(A)" — See page 63 for details.



Universal Racks

| Model No. | Size W-H-D | No. Shelves | Between Shelf Space | Ship Wt. |
|-----------|---------------------|-------------|---------------------|----------|
| 1356 | 20-7/8" x 67" x 27" | 6 | 10-1/2" | 47# |
| 1357 * | 28-1/2" x 69" x 32" | 7 | 9" | 78# |
| 1358 ** | 20-7/8" x 67" x 27" | 8 | 7-1/4" | 53# |

Four 5" platform type casters (#C450).

* Model #1357 is a *double capacity unit*.

** Model #1358 will not accept lugs.

OPTIONS:

"B", "CL(B)", "MD", "PB", "VB" — see page 63 for details.

- Ideal multipurpose rack for all departments.
- Accepts many sizes of platters, pans, boxes and lugs.
- All welded construction with 5" platform type casters.
- Lifetime warranty against rust and corrosion.



#1357



Narrow Universal Racks

| Model No. | Size W-H-D | No. Shelves | Between Shelf Space | Ship Wt. |
|--|---------------------|-------------|---------------------|----------|
| Accepts 10" x 30" or 12" x 30" Platters | | | | |
| 1354 | 16" x 42" x 32-1/2" | 5 | 7-1/4" | 37# |
| 1355 | 16" x 67" x 32-1/2" | 8 | 7-1/4" | 51# |

Four 5" platform type swivel casters (#C450).

OPTIONS:

"B", "CL(B)", "MD", "PB", "VB" - See page 63 for details.

- Designed to hold 10" x 30 or 12" x 30" platters.
- Universal bar supports.
- Lifetime warranty against rust and corrosion.



#1354



Poly Box Storage Racks

| Model No. | Size W-H-D | Pan Cap. | Runner Spacing | Ship Wt. |
|--|---------------------|----------|----------------|----------|
| End Loading - Accepts 18" x 26" or 18" x 13" Poly Boxes | | | | |
| 1481 | 21" x 70-1/4" x 26" | 8 | 7-1/2" | 42# |
| NS648 | 21" x 70-3/4" x 26" | 16 | 3-1/2" | 53# |
| 92052 | 21" x 71-3/4" x 26" | 12 | 5" | 48# |

These units will hold 18" x 26" or 18" x 13" poly food boxes, with or without covers manufactured by Cambro®, Carlisle®, Continental®, or Rubbermaid®. Rack capacity is determined by the depth of the box.

THESE UNITS WILL NOT HOLD 18" X 26" PANS.

Four 5" platform type casters - 2 swivel (#C450), 2 swivel w/ brake (#C455).

OPTIONS:

"B", "E", "M6", "MD", "PB", "PS", "VB" — see page 63 for details.



#92052



Tray Rack



#97212
Shown with optional trays
30"W x 1-1/4"H x 24"D

| Model No. | Angle Spacing | No. Of Runners | Opening Width | Rack Depth | Ship Wt. |
|-----------|---------------|----------------|---------------|------------|----------|
| 97211 | 2" | 28 | 30-1/2" | 24" | 75# |
| 97212 | 4" | 14 | 30-1/2" | 24" | 58# |
| 97213 | 2" | 28 | 30-1/2" | 36" | 94# |
| 97214 | 4" | 14 | 30-1/2" | 36" | 68# |

Aluminum Tray (.063 sheet with 1-1/4" lips, corners fused)

97215..... Aluminum Tray for #97211 & #97212
97216..... Aluminum Tray for #97213 & #97214

Four 5" platform type casters; two rigid (#C460), two swivel w/ brake (#C455).

- Organized product in spill containing, pull-out trays for easy access and viewing.
- All welded construction with 5" platform type casters.
- Lifetime warranty against rust and corrosion.



Tray Racks



#1331



#1331S

- Lean manufacturing made easy utilizing mobile tray racks.
- End loading units accommodate 13" x 18", 14" x 18", and 18" x 26" trays.
 - Side loading units accommodate 9" x 26" and 18" x 26" trays.
- Welded reinforced gussets keep the rack square.
- Lifetime warranty against rust and corrosion, superior strength and durability guaranteed.

| Model No. | Size W-H-D | Pan Cap. | Runner Spacing | Ship Wt. |
|-----------|------------|----------|----------------|----------|
|-----------|------------|----------|----------------|----------|

3/4-SIZE END LOADING RACK

1361..... 20-3/8" x 60" x 26"..... 17 3" 54#

END LOADING RACKS

1461* 20-11/16" x 69-3/4" x 26"..... 38 1-1/2" 56#
1330..... 20-3/8" x 69-3/4" x 26"..... 30 2" 70#
1331..... 20-3/8" x 69-3/4" x 26"..... 20 3" 58#
1332..... 20-3/8" x 69-3/4" x 26"..... 15 4" 49#
1333..... 20-3/8" x 69-3/4" x 26"..... 12 5" 46#
1334..... 20-3/8" x 69-3/4" x 26"..... 10 6" 42#

SIDE LOADING RACKS

1461S* 28-3/8" x 69-3/4" x 19"..... 38 1-1/2" 50#
1330S..... 28-3/8" x 69-3/4" x 19"..... 30 2" 60#
1331S..... 28-3/8" x 69-3/4" x 19"..... 20 3" 51#
1332S..... 28-3/8" x 69-3/4" x 19"..... 15 4" 45#
1333S..... 28-3/8" x 69-3/4" x 19"..... 12 5" 42#
1334S..... 28-3/8" x 69-3/4" x 19"..... 10 6" 41#

Four 5" platform type swivel casters (#C450).

* #1461 & #1461S Units Hold Pans By The Lip Only.

OPTIONS:

STANDARD UNIT OPTIONS:

"CL(B)", "B", "E", "M6", "MD", "VB", "PB", "PP(A)", "PS"
- see page 63

KNOCKED DOWN UNIT & OPTIONS:

Knocked Down Units - Add "KD" suffix to model #. (no charge)
Four 5" stem type swivel casters (#C480)
This option is not available for model #1461, #1461S or #1361.
"CL(A)", "VB" - see page 63 for details.



Enclosed Cabinets

| Model No. | Size W-H-D | Casters | Pan Cap. | H.D. Base | Ship Wt. |
|--|--------------------------------|------------|----------|-----------|----------|
| ½-SIZE ENCLOSED TRAY RACK — 1-½" Runner Spacing | | | | | |
| 1296..... | 20-7/8" x 38" x 27-5/8" | 5" (#C450) | 20 | No | 72# |
| ¾-SIZE ENCLOSED TRAY RACK — 1-½" Runner Spacing | | | | | |
| 1293..... | 20-7/8" x 56" x 27-5/8" | 5" (#C450) | 32 | Yes | 106# |
| FULL SIZE ENCLOSED TRAY RACK — 1-½" Runner Spacing | | | | | |
| 1290..... | 20-7/8" x 68" x 27-5/8" | 5" (#C450) | 40 | Yes | 113# |
| 1292* | 20-7/8" x 69" x 27-5/8" | 6" (#C510) | 38 | Yes | 137# |
| SOLID SIDES, OPEN ENDS, SOLID TOP & BOTTOM — 1-½" Spacing | | | | | |
| 1291..... | 20-7/8" x 68" x 27-5/8" | 5" (#C450) | 40 | Yes | 79# |
| SOLID SIDES; OPEN ENDS, TOP, & BOTTOM — 1-½" Runner Spacing | | | | | |
| 96328..... | 20-5/16" x 69-13/16" x 26-1/2" | 5" (#C450) | 39 | N/A | 65# |

Casters:

#C450 = 5" x 1-3/8" polyurethane platform type swivel caster.

#C510 = 6" x 2" polyolefin platform type swivel caster.

*** Equipped With A Reinforced Door — Standard**

Units hold 13" x 18", 14" x 18", and 18" x 26" pans by the lip.

OPTIONS:

"B", "MD" (excluding #1292), "PB", "CL(B)", "CL(C)" -- See page 63 for details.



#1292



"Don't Compromise....Customize."



#98908



#99995



#99791

"Don't Compromise....Customize."



#99712



#97830



#97655CD



#98926



Lean Manufacturing "Kitting Cart"

- One piece flow systems eliminates changeovers and increases efficiency.
- Reduces the work in process, inventory on assembly lines facilitating "Just-In-Time" (JIT) delivery.
- Lifetime warranty against rust and corrosion.

I.D. Tag

Identify work in process.

Hanger Strips

Stainless steel hooks optional.

Pull Out Magnetic Shelf

Magnetic steel shelf.

Counter Balanced Weight

Maintains level with shelf extended.



#99762

Specific Advantages Found By One Customer:

- Reduced "pickers" travel from 7 to 2 miles per shift, on-line WIP by 70%.
- Increased assembly line space by 13%.
- Improved flexibility in building any model, any time, to support finished good pulled.
- Creates templates, identifying what needs to be picked for each model and each station on assembly line.
- Systemizes updating of templates due to bill of material changes.
- Minimizes the possibility of assembler installing wrong part on a unit.
- Eliminated bin storage system of parts and created "Just-in-Time (JIT) delivery of sequenced mini-mart carts with exact components.



Counter Balanced Weight
Maintains level with shelf extended.



Hanger Strips
Stainless steel hooks optional.



Pull Out Magnetic Shelf
Magnetic steel shelf.

"Don't Compromise....Customize."

Pick to light conveyor sled cart...
Increases pick rates 30-50%!



#99534



#99791



Trash Dolly

| Model No. | Size W-H-D | Wt. Cap. | Ship Wt. |
|------------|-----------------------------|-----------|----------|
| 50125..... | 18-3/4" x 7" x 18-3/4"..... | 125#..... | 8# |

Five 3" stem type casters (#C405).

- Accommodates round or square "Brute" and "Huskee" containers.
- Casters are mounted at the outside perimeter which offers much more stability.
- This simple 5 caster design makes the caster footprint larger without enlarging the overall unit footprint.
- Lifetime Warranty against rust and corrosion.



Rotadolly

| Model No. | Size D-H-L | Deck Size | Ship Wt. |
|-------------|-----------------------------------|----------------|----------|
| RD2024..... | 20" x 5-5/8" x 26"..... | 20" x 24"..... | 17# |
| RD2036..... | 20" x 5-5/8" x 38"..... | 20" x 36"..... | 24# |
| 60377..... | Handle for 20" W Units Above..... | | 11# |
| RD2424..... | 24" x 5-5/8" x 26"..... | 24" x 24"..... | 20# |
| RD2436..... | 24" x 5-5/8" x 38"..... | 24" x 36"..... | 27# |
| 60328..... | Handle for 24" W Units Above..... | | 11# |

Equipped with Rotacaster wheels (#C567).

- Rotacaster wheels are multi-directional wheels using rollers rather than a swivel mount.
- Low profile dolly with frame integrated Rotacaster wheels.
- Casters are great for directional use with lateral movement.
- Flat top design allows for transporting oversize product.
- Optional removable handle installs in flush mount socket.



Multi-Directional Dolly

#RD2024 shown with, and without optional handle #60377



Rotacaster wheels have the ability to move in any direction while mounted to a fixed position - Using rollers rather than a swivel mount. They are designed to reduce fatigue and injury in the workplace



#RD2036E

Optional solid top units available



Flat Dollies



- One piece aluminum sheet design.
- Two inch sides with open corners for easy cleaning.
- Lifetime warranty against rust and corrosion.



| Model No. | Size W-H-D | With Handle | Ship Wt. |
|-----------|------------|-------------|----------|
|-----------|------------|-------------|----------|

CHILLTRAY DOLLY

| | | | |
|-------------|-------------------------|----------|-----|
| 99260..... | 19" x 6" x 23-1/2" | No..... | 13# |
| 99260H..... | 19" x 32-1/2" x 25-1/4" | Yes..... | 17# |

GLASS RACK DOLLY

| | | | |
|-------------|-------------------------|----------|-----|
| 99261..... | 21" x 6" x 21" | No..... | 15# |
| 99261H..... | 21" x 32-1/2" x 22-3/4" | Yes..... | 20# |

BUN/DOUGH DOLLY

| | | | |
|-------------|-----------------------------|----------|-----|
| 99262..... | 18-3/8" x 6" x 26-1/2" | No..... | 15# |
| 99262H..... | 18-3/8" x 32-1/2" x 28-1/4" | Yes..... | 18# |

EMPTY LUG DOLLY

| | | | |
|-------------|-------------------------|----------|-----|
| 99251..... | 17" x 6" x 26" | No..... | 13# |
| 99251H..... | 17" x 32-1/2" x 27-3/4" | Yes..... | 17# |

CHICKEN CASE DOLLY

| | | | |
|------------|--------------------|---------|-----|
| 99263..... | 15-1/4" x 6" x 23" | No..... | 15# |
|------------|--------------------|---------|-----|

Four 3" x 1-3/8" platform type swivel casters (#C410).

Pan Dollies



- Transport and store 13" x 18 and 18" x 26" pans.

| Model No. | Size W-H-D | Wt. Cap. | Ship Wt. |
|-----------|------------|----------|----------|
|-----------|------------|----------|----------|

ANGLE DOLLY WITHOUT SIDES OR HANDLE

| | | | |
|-----------|--------------------|------|-----|
| 1192..... | 18-7/8" x 7" x 27" | 800# | 20# |
|-----------|--------------------|------|-----|

ANGLE DOLLY WITH SIDES & HANDLE

| | | | |
|-----------|---------------------|-------|-----|
| 1193..... | 21" x 33-1/2" x 27" | 1000# | 22# |
|-----------|---------------------|-------|-----|

TWO TIER ANGLE DOLLY WITH SIDES & HANDLE

| | | | |
|-----------|---------------------|-------|-----|
| 1194..... | 21" x 44-1/2" x 30" | 1200# | 29# |
|-----------|---------------------|-------|-----|

ALUMINUM DRAG HOOK

| | | | |
|-----------|--------------|--|----|
| 1199..... | 37-1/2" Long | | 1# |
|-----------|--------------|--|----|

Four 5" platform type swivel casters (#C453).

Options:

"CL(B)", "MD", "PP(A)" — see page 63 for details.



Super Dolly



#1182



#1199

| Model No. | Size W-H-D | Wheel Size | Wt. Cap. | Ship Wt. |
|-----------|------------|------------|----------|----------|
|-----------|------------|------------|----------|----------|

| | | | | |
|-----------|---------------------|----|-------|-----|
| 1181..... | 24" x 10" x 29-1/2" | 6" | 2800# | 30# |
| 1182..... | 24" x 8" x 29-1/2" | 5" | 1100# | 18# |

ALUMINUM DRAG HOOK

| | | | | |
|-----------|--------------|--|--|----|
| 1199..... | 37-1/2" Long | | | 1# |
|-----------|--------------|--|--|----|

Four platform type casters - two swivel, two rigid.

#1181= 2 swivel (#C490) 2 rigid (#C500)

#1182 = 2 swivel (#C450) 2 rigid (#C460)

Options:

"B", "CL(C) (Model #1181), "CL(B) (Model #1182) - see page 63.



Mobile Dunnage Storage

| Model No. | Size D-H-L | Wt. Cap. | Ship Wt. |
|-----------|------------------------------|----------|----------|
| 1201..... | 20" x 8-1/4" x 25-3/4" | 1200# | 17# |
| 1211..... | 20" x 8-1/4" x 31-3/4" | 1200# | 19# |
| 1202..... | 20" x 8-1/4" x 37-3/4" | 1200# | 19# |
| 1200..... | 20" x 8-1/4" x 43-3/4" | 1200# | 21# |
| 1203..... | 20" x 8-1/4" x 49-3/4" | 1200# | 22# |
| 1212..... | 20" x 8-1/4" x 61-3/4" | 1200# | 24# |
| 1208..... | Handle for 20" W Units Above | | 4# |
| 1213..... | 24" x 8-1/4" x 25-3/4" | 1200# | 20# |
| 1214..... | 24" x 8-1/4" x 31-3/4" | 1200# | 19# |
| 1204..... | 24" x 8-1/4" x 37-3/4" | 1200# | 20# |
| 1205..... | 24" x 8-1/4" x 43-3/4" | 1200# | 21# |
| 1206..... | 24" x 8-1/4" x 49-3/4" | 1200# | 22# |
| 1207..... | 24" x 8-1/4" x 61-3/4" | 1200# | 25# |
| 1174..... | Handle for 24" W Units Above | | 4# |

Four 5" plate type casters •
 2- swivel w/ brake (#C455) • 2- rigid (#C460)

OPTIONS:

Heavy Duty Casters -Add "HD6" suffix to model #.

Four 6" plate type casters- (2) swivel w/ brake (#C495) • (2) rigid (#C500).

All Swivel Casters -Add "SW" suffix to model #.

- Transport and store product without having to load and unload it!
- Labor Saving!



Mobile Dunnage Rack
 shown with, and without optional handle



Stationary Dunnage Storage

| Model No. | # of Lat. | Wt. Cap. | Size D-H-L | Ship Wt. |
|-----------|-----------|----------|-----------------|----------|
| 6017..... | 4 | 2000# | 20" x 8" x 36" | 8# |
| 6018..... | 4 | 2000# | 20" x 8" x 48" | 10# |
| 6019..... | 4 | 1500# | 20" x 8" x 60" | 12# |
| 6004..... | 4 | 2000# | 20" x 12" x 36" | 8# |
| 6005..... | 4 | 2000# | 20" x 12" x 48" | 10# |
| 6006..... | 4 | 1500# | 20" x 12" x 60" | 12# |
| 6014..... | 5 | 2000# | 24" x 8" x 36" | 9# |
| 6015..... | 5 | 2000# | 24" x 8" x 48" | 12# |
| 6016..... | 5 | 1500# | 24" x 8" x 60" | 14# |
| 6008..... | 5 | 2000# | 24" x 12" x 36" | 10# |
| 6009..... | 5 | 2000# | 24" x 12" x 48" | 12# |
| 6010..... | 5 | 1500# | 24" x 12" x 60" | 15# |



6000 SERIES - Dunnage Racks



Stationary Dunnage Storage



2000 SERIES - Dunnage Racks

- All feet are permanently sealed with welded aluminum caps... Not plastic.
- All welded aluminum racks keep product organized and off of the floor.
- Lifetime warranty against rust and corrosion.



| Model No. | Size D-H-L | Wt. Cap. | # of Lat. | Ship Wt. |
|------------|-----------------|----------|-----------|----------|
| 2001..... | 18" x 8" x 36" | 3000# | 4 | 9# |
| 2002..... | 18" x 8" x 48" | 2500# | 4 | 11# |
| 2003..... | 18" x 8" x 60" | 2000# | 4 | 13# |
| 2029..... | 18" x 12" x 24" | 3200# | 4 | 7# |
| 2020..... | 18" x 12" x 36" | 3000# | 4 | 10# |
| 2021..... | 18" x 12" x 48" | 2500# | 4 | 12# |
| 2022..... | 18" x 12" x 60" | 2000# | 4 | 14# |
| 2017..... | 20" x 8" x 36" | 3000# | 4 | 9# |
| 2018..... | 20" x 8" x 48" | 2500# | 4 | 11# |
| 2019..... | 20" x 8" x 60" | 2000# | 4 | 13# |
| 2052..... | 20" x 12" x 30" | 3000# | 4 | 9# |
| 2004..... | 20" x 12" x 36" | 3000# | 4 | 10# |
| 2054..... | 20" x 12" x 42" | 3000# | 4 | 11# |
| 2005..... | 20" x 12" x 48" | 2500# | 4 | 12# |
| 2006..... | 20" x 12" x 60" | 2000# | 4 | 14# |
| 2031..... | 24" x 8" x 24" | 3000# | 5 | 8# |
| 2014..... | 24" x 8" x 36" | 2500# | 5 | 11# |
| 2015..... | 24" x 8" x 48" | 2500# | 5 | 14# |
| 2016..... | 24" x 8" x 60" | 2000# | 5 | 17# |
| 2032*..... | 24" x 8" x 72" | 4000# | 5 | 21# |
| 2013..... | 24" x 12" x 24" | 2500# | 5 | 9# |
| 2062..... | 24" x 12" x 30" | 2500# | 5 | 10# |
| 2008..... | 24" x 12" x 36" | 2500# | 5 | 11# |
| 2064..... | 24" x 12" x 42" | 2500# | 5 | 13# |
| 2009..... | 24" x 12" x 48" | 2500# | 5 | 14# |
| 2033..... | 24" x 12" x 54" | 2000# | 5 | 17# |
| 2010..... | 24" x 12" x 60" | 2000# | 5 | 18# |
| 2012*..... | 24" x 12" x 72" | 4000# | 5 | 22# |
| 2026..... | 30" x 12" x 36" | 3000# | 6 | 14# |
| 2027..... | 30" x 12" x 48" | 3000# | 6 | 16# |
| 2028..... | 30" x 12" x 60" | 2500# | 6 | 20# |
| 2007*..... | 30" x 12" x 72" | 2500# | 6 | 25# |

* Models have 6 legs

OPTIONS :

- Removable Aluminum Cover** — Call For Pricing
- Custom Sizes Available** — Call For Pricing

Equipment Stand



#24ESS29US
shown with optional undershelf

| Model No. | Size W-H-D | Top Style | Ship Wt. |
|---------------|-----------------|----------------|----------|
| 24ESS29 | 24" x 24" x 29" | Stainless..... | 31# |
| 24ESA29 | 24" x 24" x 29" | Aluminum..... | 23# |

Units equipped with NSF Certified adjustable feet.

OPTIONS:

Aluminum Undershelf - Add "US" suffix to model #.

Casters - Add suffix "999" to model #.

- All swivel with brake (#C447). • Height with casters = 24".

**** Casters Are Factory Installed Only ****

- Aluminum tube frame design.
- Shoe box type top nests on frame.
- Lifetime warranty against rust and corrosion.



Modular Equipment Stand



#12448GSC



#21524ES24P • #21524ES30PC

| Model No. | Size D-H-L | Ship Wt. |
|-------------------------|-----------------|----------|
| STATIONARY UNITS | | |
| 12436GS | 24" x 24" x 36" | 27.5# |
| 12448GS | 24" x 24" x 48" | 32# |
| 12460GS | 24" x 24" x 60" | 37# |
| 12472GS | 24" x 24" x 72" | 42# |
| 13036GS | 30" x 24" x 36" | 31# |
| 13048GS | 30" x 24" x 48" | 37# |
| 13060GS | 30" x 24" x 60" | 42# |
| 13072GS | 30" x 24" x 72" | 48# |

| STATIONARY UNIT W/ UNDERSHELF | | |
|--------------------------------------|-----------------|-----|
| 12436GSU | 24" x 24" x 36" | 34# |
| 12448GSU | 24" x 24" x 48" | 41# |
| 12460GSU | 24" x 24" x 60" | 47# |
| 12472GSU | 24" x 24" x 72" | 55# |
| 13036GSU | 30" x 24" x 36" | 39# |
| 13048GSU | 30" x 24" x 48" | 47# |
| 13060GSU | 30" x 24" x 60" | 55# |
| 13072GSU | 30" x 24" x 72" | 63# |

| MOBILE UNIT | | |
|--------------------|-----------------|-----|
| 12436GSC | 24" x 24" x 36" | 38# |
| 12448GSC | 24" x 24" x 48" | 42# |
| 12460GSC | 24" x 24" x 60" | 47# |
| 12472GSC | 24" x 24" x 72" | 52# |
| 13036GSC | 30" x 24" x 36" | 41# |
| 13048GSC | 30" x 24" x 48" | 47# |
| 13060GSC | 30" x 24" x 60" | 52# |
| 13072GSC | 30" x 24" x 72" | 59# |

Four 5" Stem Casters (#C440)

| MOBILE UNIT WITH UNDERSHELF | | |
|------------------------------------|-----------------|-----|
| 12436GSCU | 24" x 24" x 36" | 44# |
| 12448GSCU | 24" x 24" x 48" | 51# |
| 12460GSCU | 24" x 24" x 60" | 57# |
| 12472GSCU | 24" x 24" x 72" | 65# |
| 13036GSCU | 30" x 24" x 36" | 49# |
| 13048GSCU | 30" x 24" x 48" | 57# |
| 13060GSCU | 30" x 24" x 60" | 65# |
| 13072GSCU | 30" x 24" x 72" | 74# |

Four 5" Stem Casters (#C440).

Weight Capacity = 1000#



| Model No. | Size D-H-L | Ship Wt. |
|-----------|------------|----------|
|-----------|------------|----------|

Adjustable Solid Shelves (2) - 400# capacity per shelf

| | | |
|------------|-----------------|-----|
| 21524ES24P | 15" x 24" x 24" | 18# |
| 21530ES24P | 15" x 24" x 30" | 21# |
| 21536ES24P | 15" x 24" x 36" | 22# |
| 21542ES24P | 15" x 24" x 42" | 23# |
| 21548ES24P | 15" x 24" x 48" | 26# |
| 21824ES24P | 18" x 24" x 24" | 20# |
| 21830ES24P | 18" x 24" x 30" | 23# |
| 21836ES24P | 18" x 24" x 36" | 23# |
| 21842ES24P | 18" x 24" x 42" | 27# |
| 21848ES24P | 18" x 24" x 48" | 31# |
| 22024ES24P | 20" x 24" x 24" | 23# |
| 22030ES24P | 20" x 24" x 30" | 25# |
| 22036ES24P | 20" x 24" x 36" | 26# |
| 22042ES24P | 20" x 24" x 42" | 28# |
| 22048ES24P | 20" x 24" x 48" | 34# |
| 21524ES30P | 15" x 30" x 24" | 19# |
| 21530ES30P | 15" x 30" x 30" | 22# |
| 21536ES30P | 15" x 30" x 36" | 23# |
| 21542ES30P | 15" x 30" x 42" | 24# |
| 21548ES30P | 15" x 30" x 48" | 27# |
| 21824ES30P | 18" x 30" x 24" | 21# |
| 21830ES30P | 18" x 30" x 30" | 24# |
| 21836ES30P | 18" x 30" x 36" | 24# |
| 21842ES30P | 18" x 30" x 42" | 28# |
| 21848ES30P | 18" x 30" x 48" | 32# |
| 22024ES30P | 20" x 30" x 24" | 24# |
| 22030ES30P | 20" x 30" x 30" | 26# |
| 22036ES30P | 20" x 30" x 36" | 27# |
| 22042ES30P | 20" x 30" x 42" | 29# |
| 22048ES30P | 20" x 30" x 48" | 35# |
| 21524ES36P | 15" x 36" x 24" | 20# |
| 21530ES36P | 15" x 36" x 30" | 23# |
| 21536ES36P | 15" x 36" x 36" | 24# |
| 21542ES36P | 15" x 36" x 42" | 25# |
| 21548ES36P | 15" x 36" x 48" | 28# |
| 21824ES36P | 18" x 36" x 24" | 22# |
| 21830ES36P | 18" x 36" x 30" | 25# |
| 21836ES36P | 18" x 36" x 36" | 25# |
| 21842ES36P | 18" x 36" x 42" | 29# |
| 21848ES36P | 18" x 36" x 48" | 33# |
| 22024ES36P | 20" x 36" x 24" | 25# |
| 22030ES36P | 20" x 36" x 30" | 27# |
| 22036ES36P | 20" x 36" x 36" | 28# |
| 22042ES36P | 20" x 36" x 42" | 30# |
| 22048ES36P | 20" x 36" x 48" | 36# |

Options:

Casters (4): Add "C" suffix to model #.

Swivel Stem Casters w/ brakes (#C440)



All Welded Shelving - H.D. Series



Mobile - All Welded Unit
w/ Optional "M6" Casters

All Welded Shelving - H.D. Series

- Built to organize larger, heavier loads.
- New Age uses the heaviest aluminum extrusion for maximum life and strength.
- Mobile units available —Factory installed only.
- **All non-mobile units include adjustable feet.**
- Lifetime warranty against rust and corrosion, **superior** for refrigerated environments.



| Model No. | Size D-H-L | Shelf Lat. | Ship Wt. |
|-----------|------------|------------|----------|
|-----------|------------|------------|----------|

TWO SHELF UNIT - 34-1/2" Shelf Clearance

| | | | |
|-----------|-----------------|---|-----|
| 1021..... | 20" x 48" x 36" | 4 | 24# |
| 1030..... | 20" x 48" x 42" | 4 | 26# |
| 1022..... | 20" x 48" x 48" | 4 | 28# |
| 1023..... | 20" x 48" x 60" | 4 | 32# |
| 1024..... | 20" x 48" x 72" | 4 | 36# |
| 1025..... | 24" x 48" x 36" | 5 | 27# |
| 1031..... | 24" x 48" x 42" | 5 | 29# |
| 1026..... | 24" x 48" x 48" | 5 | 32# |
| 1027..... | 24" x 48" x 60" | 5 | 37# |
| 1028..... | 24" x 48" x 72" | 5 | 42# |

THREE SHELF UNIT - 22-1/2" Shelf Clearance

| | | | |
|-----------|-----------------|---|-----|
| 1041..... | 20" x 60" x 36" | 4 | 33# |
| 1050..... | 20" x 60" x 42" | 4 | 35# |
| 1042..... | 20" x 60" x 48" | 4 | 38# |
| 1043..... | 20" x 60" x 60" | 4 | 44# |
| 1044..... | 20" x 60" x 72" | 4 | 50# |
| 1045..... | 24" x 60" x 36" | 5 | 38# |
| 1051..... | 24" x 60" x 42" | 5 | 40# |
| 1046..... | 24" x 60" x 48" | 5 | 45# |
| 1047..... | 24" x 60" x 60" | 5 | 52# |
| 1048..... | 24" x 60" x 72" | 5 | 59# |

FOUR SHELF UNIT - 18-1/2" Shelf Clearance

| | | | |
|-----------|-----------------|---|-----|
| 1061..... | 20" x 72" x 36" | 4 | 41# |
| 1070..... | 20" x 72" x 42" | 4 | 45# |
| 1062..... | 20" x 72" x 48" | 4 | 49# |
| 1063..... | 20" x 72" x 60" | 4 | 57# |
| 1064..... | 20" x 72" x 72" | 4 | 65# |
| 1065..... | 24" x 72" x 36" | 5 | 48# |
| 1071..... | 24" x 72" x 42" | 5 | 53# |
| 1066..... | 24" x 72" x 48" | 5 | 58# |
| 1067..... | 24" x 72" x 60" | 5 | 68# |
| 1068..... | 24" x 72" x 72" | 5 | 77# |

MOBILE UNITS — FACTORY OPTIONS ONLY

6" Platform casters (#C490)
- Add "M6" suffix to model #.

5" Platform casters (#C450)
- Add "M5" suffix to model #.

ADDITIONAL ADJUSTABLE FEET:

Model #0117

OPTIONS:

"CL(B)", "CL(C)", "PP(A)" - see page 63.



All Welded Shelving - T-Bar Series

| Model No. | Size D-H-L | Ship Wt. |
|---|-----------------|----------|
| TWO SHELF UNIT - 34-½" Shelf Clearance | | |
| 1021TB | 20" x 48" x 36" | 28# |
| 1030TB | 20" x 48" x 42" | 31# |
| 1022TB | 20" x 48" x 48" | 33# |
| 1023TB | 20" x 48" x 60" | 38# |
| 1024TB | 20" x 48" x 72" | 44# |
| 1025TB | 24" x 48" x 36" | 30# |
| 1031TB | 24" x 48" x 42" | 35# |
| 1026TB | 24" x 48" x 48" | 37# |
| 1027TB | 24" x 48" x 60" | 43# |
| 1028TB | 24" x 48" x 72" | 49# |

| | | |
|---|-----------------|-----|
| THREE SHELF UNIT - 22-½" Shelf Clearance | | |
| 1041TB | 20" x 60" x 36" | 38# |
| 1050TB | 20" x 60" x 42" | 42# |
| 1042TB | 20" x 60" x 48" | 46# |
| 1043TB | 20" x 60" x 60" | 54# |
| 1044TB | 20" x 60" x 72" | 62# |
| 1045TB | 24" x 60" x 36" | 42# |
| 1051TB | 24" x 60" x 42" | 47# |
| 1046TB | 24" x 60" x 48" | 51# |
| 1047TB | 24" x 60" x 60" | 61# |
| 1048TB | 24" x 60" x 72" | 70# |

| | | |
|--|-----------------|-----|
| FOUR SHELF UNIT - 18-½" Shelf Clearance | | |
| 1061TB | 20" x 72" x 36" | 48# |
| 1070TB | 20" x 72" x 42" | 55# |
| 1062TB | 20" x 72" x 48" | 59# |
| 1063TB | 20" x 72" x 60" | 70# |
| 1064TB | 20" x 72" x 72" | 81# |
| 1065TB | 24" x 72" x 36" | 54# |
| 1071TB | 24" x 72" x 42" | 60# |
| 1066TB | 24" x 72" x 48" | 66# |
| 1067TB | 24" x 72" x 60" | 79# |
| 1068TB | 24" x 72" x 72" | 91# |

MOBILE UNITS — FACTORY OPTIONS ONLY

6" Platform casters (#C490)
- Add "M6" suffix to model #.

5" Platform casters (#C450)
- Add "M5" suffix to model #.

ADDITIONAL ADJUSTABLE FEET:

Model #0117

OPTIONS:

"CL(B)", "CL(C)", "PP(A)" - see page 63.



All Welded Shelving — T-Bar Series



Mobile - All Welded Unit
w/ Optional "M5" Casters

- Each unit has easy-to-clean flat surfaces that aid in the easy-on and easy-off of smaller product with the strength to hold heavy product.
- Mobile units available — Factory installed only.
- These all welded units keep product organized and off of the floor while providing adequate air flow.
- New Age "T's" are 2-¼" wide and spaced 1-¾" apart, giving our T-Bar shelves the most surface area.
- **All non-mobile units include adjustable feet.**
- Lifetime warranty against rust and corrosion, **superior** for refrigerated environments.



Adjust-A-Shelf Shelving - H.D. Series

You Tube > <http://www.youtube.com/user/NewAgeInd#p/u/4/ctg-us5CCCM>



Make your unit mobile with easy to install, #C440 casters.

- All swivel with brakes.
- Can be installed any time.
- See page 49 for details.



Adjust-A-Shelf — H.D. Series

- With weight capacities at **one ton** (2000#) per shelf, these units will hold almost anything!
- Built To Organize Large, Heavy Loads.
- Lifetime warranty against rust and corrosion, **superior** for refrigerated environments.

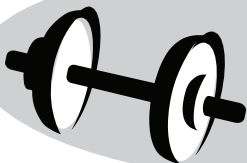

2000#
Weight Capacity
per shelf

| Model No. | Size D-L | # Of Lat. | Ship Wt. |
|-----------|-----------|-----------|----------|
| 1530HD | 15" x 30" | 3 | 5# |
| 1536HD | 15" x 36" | 3 | 6# |
| 1542HD | 15" x 42" | 3 | 7# |
| 1548HD | 15" x 48" | 3 | 8# |
| 1554HD | 15" x 54" | 3 | 9# |
| 1560HD | 15" x 60" | 3 | 9.5# |
| 1566HD | 15" x 66" | 3 | 10# |
| 1572HD | 15" x 72" | 3 | 11# |
| 1830HD | 18" x 30" | 4 | 7# |
| 1836HD | 18" x 36" | 4 | 8# |
| 1842HD | 18" x 42" | 4 | 9# |
| 1848HD | 18" x 48" | 4 | 10# |
| 1854HD | 18" x 54" | 4 | 11# |
| 1860HD | 18" x 60" | 4 | 12# |
| 1866HD | 18" x 66" | 4 | 13# |
| 1872HD | 18" x 72" | 4 | 14# |
| 2030HD | 20" x 30" | 4 | 7# |
| 2036HD | 20" x 36" | 4 | 8# |
| 2042HD | 20" x 42" | 4 | 9# |
| 2048HD | 20" x 48" | 4 | 10# |
| 2054HD | 20" x 54" | 4 | 11# |
| 2060HD | 20" x 60" | 4 | 12# |
| 2066HD | 20" x 66" | 4 | 13# |
| 2072HD | 20" x 72" | 4 | 14# |
| 2096HD* | 20" x 96" | 4 | 19# |
| 2430HD | 24" x 30" | 5 | 9# |
| 2436HD | 24" x 36" | 5 | 10# |
| 2442HD | 24" x 42" | 5 | 11# |
| 2448HD | 24" x 48" | 5 | 12# |
| 2454HD | 24" x 54" | 5 | 14# |
| 2460HD | 24" x 60" | 5 | 15# |
| 2466HD | 24" x 66" | 5 | 16# |
| 2472HD | 24" x 72" | 5 | 17# |
| 2496HD* | 24" x 96" | 5 | 24# |
| 3030HD | 30" x 30" | 6 | 10.5# |
| 3036HD | 30" x 36" | 6 | 12# |
| 3048HD | 30" x 48" | 6 | 15# |

Constructed of 1-1/2" x 1-3/4" extruded aluminum tubing.

* 96" Shelves Require 6 Posts.

See Page 49 For Posts & Accessories

Design Your Own Custom Unit

- All three series of "Adjust-A-Shelf" Shelving (the same length and width) are interchangeable.
- This allows you to custom make your own complete units with the type of shelving (H.D., T-Bar, Solid Brute) you need.
- Each unit assembles in minutes with only an allen wrench.



Adjust-A-Shelf Shelving - T-Bar Series

You Tube > <http://www.youtube.com/user/NewAgeInd#p/u/4/ctg-us5CCCM>

| Model No. | Size D-L | Ship Wt. |
|-----------|-----------|----------|
| 1530TB | 15" x 30" | 6# |
| 1536TB | 15" x 36" | 7# |
| 1542TB | 15" x 42" | 8# |
| 1548TB | 15" x 48" | 10# |
| 1554TB | 15" x 54" | 10# |
| 1560TB | 15" x 60" | 11# |
| 1566TB | 15" x 66" | 12# |
| 1572TB | 15" x 72" | 13# |
| 1830TB | 18" x 30" | 7# |
| 1836TB | 18" x 36" | 8# |
| 1842TB | 18" x 42" | 9# |
| 1848TB | 18" x 48" | 11# |
| 1854TB | 18" x 54" | 12# |
| 1860TB | 18" x 60" | 13# |
| 1866TB | 18" x 66" | 14# |
| 1872TB | 18" x 72" | 16# |
| 2030TB | 20" x 30" | 8# |
| 2036TB | 20" x 36" | 9# |
| 2042TB | 20" x 42" | 10# |
| 2048TB | 20" x 48" | 12# |
| 2054TB | 20" x 54" | 13# |
| 2060TB | 20" x 60" | 14# |
| 2066TB | 20" x 66" | 15# |
| 2072TB | 20" x 72" | 17# |
| 2430TB | 24" x 30" | 9# |
| 2436TB | 24" x 36" | 11# |
| 2442TB | 24" x 42" | 12# |
| 2448TB | 24" x 48" | 14# |
| 2454TB | 24" x 54" | 15# |
| 2460TB | 24" x 60" | 17# |
| 2466TB | 24" x 66" | 18# |
| 2472TB | 24" x 72" | 20# |

See Page 49 For Posts & Accessories



Make your unit mobile with easy to install, #C440 casters.

- All swivel with brakes.
- Can be installed any time.
- See page 49 for details.



Adjust-A-Shelf — T-Bar Series

Design Your Own Custom Unit

- All three series of "Adjust-A-Shelf" Shelving (the same length and width) are interchangeable.
- This allows you to custom make your own complete units with the type of shelving (H.D., T-Bar, Solid Brute) you need.
- Each unit assembles in minutes with only an allen wrench.

- Unique T-Bar construction allows for easy-on, easy-off of product for easy storage while providing maximum air circulation.
- Wide T-Bar and 1-3/4" space between "T"s gives more welds per "T" and more shelf surface.
- Lifetime warranty against rust and corrosion, **superior** for refrigerated environments.

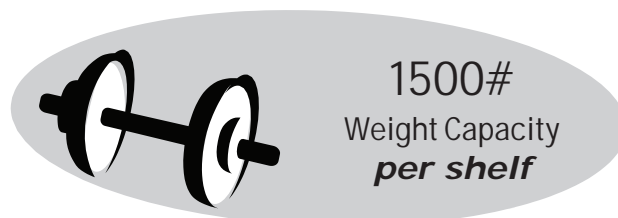

Adjust-A-Shelf Shelving - Solid Brute Series

You Tube > <http://www.youtube.com/user/NewAgeInd#p/u/4/ctg-us5CCCM>



Make your unit mobile with easy to install, #C440 casters.

- All swivel with brakes.
- Can be installed any time.
- See page 49 for details.



Adjust-A-Shelf - Solid Brute Series

- **Unique removable top permits easy clean-up while the reinforced under-bracing gives added support.**
- Lifetime warranty against rust and corrosion, **superior** for refrigerated environments.
 - 10" back wheels allow for easy maneuverability on any surface.
- Self-supporting design reduces fatigue.

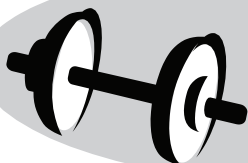

800#
Weight Capacity
per shelf

| Model No. | Size D-L | Ship Wt. |
|-------------|-----------|----------|
| 1530SB..... | 15" x 30" | 8# |
| 1536SB..... | 15" x 36" | 10# |
| 1542SB..... | 15" x 42" | 11# |
| 1548SB..... | 15" x 48" | 12# |
| 1554SB..... | 15" x 54" | 13# |
| 1560SB..... | 15" x 60" | 14# |
| 1830SB..... | 18" x 30" | 9# |
| 1836SB..... | 18" x 36" | 10# |
| 1842SB..... | 18" x 42" | 12# |
| 1848SB..... | 18" x 48" | 13# |
| 1854SB..... | 18" x 54" | 14# |
| 1860SB..... | 18" x 60" | 15# |
| 1872SB..... | 18" x 72" | 18# |
| 2030SB..... | 20" x 30" | 9# |
| 2036SB..... | 20" x 36" | 11# |
| 2042SB..... | 20" x 42" | 12# |
| 2048SB..... | 20" x 48" | 13# |
| 2054SB..... | 20" x 54" | 14# |
| 2060SB..... | 20" x 60" | 16# |
| 2066SB..... | 20" x 66" | 17# |
| 2072SB..... | 20" x 72" | 18# |
| 2430SB..... | 24" x 30" | 10# |
| 2436SB..... | 24" x 36" | 12# |
| 2442SB..... | 24" x 42" | 13# |
| 2448SB..... | 24" x 48" | 14# |
| 2454SB..... | 24" x 54" | 16# |
| 2460SB..... | 24" x 60" | 17# |
| 2466SB..... | 24" x 66" | 18# |
| 2472SB..... | 24" x 72" | 20# |

This solid shelf with reinforced bars provides a flat, smooth surface.

See Page 49 For Posts & Accessories

Design Your Own Custom Unit

- All three series of "Adjust-A-Shelf" Shelving (the same length and width) are interchangeable.
- This allows you to custom make your own complete units with the type of shelving (H.D., T-Bar, Solid Brute) you need.
- Each unit assembles in minutes with only an allen wrench.



Adjustable H.D. Shelf

| Model No. | Wt. Cap. | Size W-L | Ship Wt. |
|-----------|----------|-----------|----------|
| C1836HD | 1100# | 18" x 36" | 6# |
| C1848HD | 1100# | 18" x 48" | 7# |
| C1860HD | 1100# | 18" x 60" | 9# |
| C2436HD | 1100# | 24" x 36" | 7# |
| C2448HD | 1100# | 24" x 48" | 9# |
| C2460HD | 1100# | 24" x 60" | 11# |
| C2472HD | 500# | 24" x 72" | 13# |

See Page 49 For Posts & Accessories

- Built to accommodate heavier product and designed for use in all environments including freezers, coolers, as well as packaging and storage areas.
- Lifetime warranty against rust and corrosion.



H.D. Style Shelf



Adjustable T-Bar Shelf

| Model No. | Wt. Cap. | Size W-L | Ship Wt. |
|-----------|----------|-----------|----------|
| C1836TB | 900# | 18" x 36" | 7# |
| C1848TB | 900# | 18" x 48" | 8# |
| C1860TB | 900# | 18" x 60" | 10# |
| C2436TB | 900# | 24" x 36" | 8# |
| C2448TB | 900# | 24" x 48" | 10# |
| C2460TB | 900# | 24" x 60" | 12# |
| C2472TB | 500# | 24" x 72" | 14# |

See Page 49 For Posts & Accessories

- Built to accommodate smaller item and heavier loads for use in all environments including freezers, coolers, as well as packaging and storage areas.
- Lifetime warranty against rust and corrosion.



T-Bar Style Shelf



Adjustable Solid Shelf

| Model No. | Wt. Cap. | Size D-L | Ship Wt. |
|-----------|----------|-----------|----------|
| 1530S | 400# | 15" x 30" | 6# |
| 1536S | 400# | 15" x 36" | 7# |
| 1542S | 400# | 15" x 42" | 8# |
| 1548S | 400# | 15" x 48" | 8# |
| 1830S | 400# | 18" x 30" | 7# |
| 1836S | 400# | 18" x 36" | 8# |
| 1842S | 400# | 18" x 42" | 8# |
| 1848S | 400# | 18" x 48" | 9# |
| 2030S | 400# | 20" x 30" | 8# |
| 2036S | 400# | 20" x 36" | 9# |
| 2042S | 400# | 20" x 42" | 9# |
| 2048S | 400# | 20" x 48" | 10# |

Economical solid shelf with double thick marine edge.

See Page 49 For Posts & Accessories

- **Organizes Smaller, Lighter Product.** Solid sheet design permits easy clean-up and minimizes the mess of "leaky" products.



Solid Style Shelf



Adjust-A-Shelf Shelving - Accessories



Floor Post Bracket



Wall Bracket

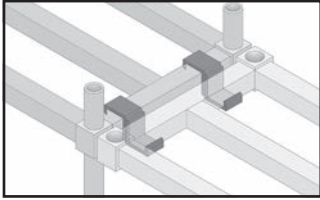

Pole Clip



| Model No. | Item Description | Ship Wt. |
|-----------|------------------|----------|
|-----------|------------------|----------|

BRACKETS

| | | |
|-------|--|-----|
| NS496 | Countertop/Floor Post Brackets | .5# |
| NS885 | Wall Brackets (pair): Secures Shelving to Wall | .5# |

Attach shelving units to the floor or wall to meet the Seismic Requirements of most states.

POLE CLIPS

| | | |
|-------|---|-----|
| PC432 | Common Pole Clips (pair) H.D. & T-Bar Shelves | .5# |
|-------|---|-----|

Clip two units together, shelf to shelf, and eliminate two posts.

U-BRACES

| | | |
|--------|-------------------------------|----|
| 2036UB | U-Brace for 20" x 36" Shelves | 4# |
| 2042UB | U-Brace for 20" x 42" Shelves | 4# |
| 2048UB | U-Brace for 20" x 48" Shelves | 5# |
| 2060UB | U-Brace for 20" x 60" Shelves | 5# |
| 2436UB | U-Brace for 24" x 36" Shelves | 5# |
| 2442UB | U-Brace for 24" x 42" Shelves | 5# |
| 2448UB | U-Brace for 24" x 48" Shelves | 5# |
| 2460UB | U-Brace for 24" x 60" Shelves | 6# |

Adds extra support, keeping posts stable between large spans.

CASTERS

| | | |
|------|--------------------------------|----|
| C440 | 5" Stem Type Casters w/ Brakes | 3# |
|------|--------------------------------|----|

Casters are heavy duty, easily installed, and can be added in the field.

ADJUSTABLE FEET

| | | |
|------|-----------------|-----|
| O116 | Adjustable Feet | .5# |
|------|-----------------|-----|

Adjustable Feet are easily installed, and can be added in the field.

Posts



Capped aluminum pipe (1-⁵/₁₆" o.d.).
Marked in 2" increments.

| Model No. | Length | Ship Wt. |
|-----------|--------|----------|
| 12P | 12" | .6# |
| 34P | 34" | 2# |
| 48P | 48" | 3# |
| 54P | 54" | 3# |
| 68P | 68" | 4# |
| 72P | 72" | 4# |
| 76P | 76" | 4# |
| 84P | 84" | 5# |
| 96P | 96" | 5# |

Design Your Own Custom Unit

- All three series of "Adjust-A-Shelf" Shelving (the same length and width) are interchangeable.
- This allows you to custom make your own complete units with the type of shelving (H.D., T-Bar, Solid Brute) you need.
- Each unit assembles in minutes with only an allen wrench.



HD Mobile Base



#50311

| Model No. | Size D-H-L | Wt. Cap. | Ship Wt. |
|-----------|--|----------|----------|
| 50310 | 24" x 9- ³ / ₈ " x 36" | 800# | 22# |
| 50311 | 24" x 9- ³ / ₈ " x 48" | 800# | 28# |
| 50312 | 24" x 9- ³ / ₈ " x 60" | 800# | 34# |

Four 5" platform casters -two swivel (#C455), two rigid (#C460).

Options:

SIX WHEEL - ZERO TURNING — Add "X6" suffix to model #.
- Six 5" platform casters - four swivel (#C455), two rigid (#C460).



Mega Shelving

| Model No. | Size D-H-L | ½-Barrel Cap. | No. Shelves | Ship Wt. |
|---|-----------------|---------------|-------------|----------|
| COMPLETE UNITS - ADJUSTABLE, SHIPPED "KNOCKED-DOWN" | | | | |
| 31842TT7 | 18" x 76" x 42" | 4 | 3 | 45# |
| NS933 | 18" x 76" x 60" | 6 | 3 | 66# |
| 1288 | 18" x 76" x 80" | 8 | 3 | 78# |
| 1289 * | 18" x 76" x 93" | 10 | 3 | 93# |
| MEGA SHELVES ONLY-Posts (see pg 45) *Customize Your Own Units* | | | | |
| 94273 | 18" x 3" x 60" | 3 | 1 | 14.5# |
| 94274 | 18" x 3" x 80" | 4 | 1 | 19# |
| 94275 * | 18" x 3" x 93" | 5 | 1 | 23# |
| WALL PROTECTORS | | | | |
| 94029 | 18" x 2" x 60" | | | 7.5# |
| 94030 | 18" x 2" x 80" | | | 9# |
| 94031 * | 18" x 2" x 93" | | | 10# |

* 93" Shelves Require Six Posts.



#NS933



Wall Shelves

| Model No. | Size D-L | Wt. Cap. | # Of Hooks | Ship Wt. |
|---|---------------------|----------|------------|----------|
| T-BAR WALL SHELF WITH HANGER AND HOOKS | | | | |
| 1121PR | 20" x 36" | 700 | 6 | 15# |
| 1122PR | 20" x 48" | 600 | 7 | 21# |
| 1123PR | 20" x 60" | 500 | 8 | 26# |
| 0119 | Additional Hook (1) | | | |

Adjustable hooks slide easily into place to fit your needs.

| Model No. | Size D-L | Wt. Cap. | Ship Wt. |
|---------------------------|-----------|----------|----------|
| T-BAR WALL SHELVES | | | |
| 1121 | 20" x 36" | 700 | 11# |
| 1122 | 20" x 48" | 600 | 14# |
| 1123 | 20" x 60" | 500 | 16# |
| 1124 | 24" x 60" | 500 | 26# |

Heavy duty shelf design for larger, heavier product.

| SOLID WALL SHELVES- REGULAR 18 GA | | | |
|--|-----------|-----|----|
| NS675 | 12" x 24" | 200 | 5# |
| 1125 | 12" x 36" | 150 | 7# |
| 1126 | 12" x 48" | 125 | 8# |
| 1127 | 12" x 60" | 100 | 9# |

For lighter loads and smaller product, contains spills.

| SOLID WALL SHELVES - HEAVY DUTY 12 GA | | | |
|--|-----------|-----|-----|
| NS675A | 12" x 24" | 300 | 6# |
| 1125A | 12" x 36" | 300 | 8# |
| 1126A | 12" x 48" | 225 | 11# |
| 1127A | 12" x 60" | 150 | 13# |
| NS753 | 15" x 24" | 300 | 5# |
| NS943 | 15" x 36" | 300 | 7# |
| NS793 | 15" x 48" | 225 | 11# |
| 94249 | 15" x 60" | 150 | 12# |
| 95634 | 18" x 24" | 300 | 8# |
| 92093 | 18" x 36" | 300 | 10# |
| 92094 | 18" x 48" | 225 | 13# |
| 94136 | 18" x 60" | 150 | 15# |

Thick, 12 gauge for heavier loads. Performs like stainless steel.

OPTIONS: Extra Undershelf Brackets - Call Factory

| INVERTED SHELVES - HEAVY DUTY 12 GA | | | |
|--|-----------|-----|-----|
| 97285 | 20" x 36" | 500 | 11# |
| 97286 | 20" x 48" | 500 | 14# |
| 97287 | 20" x 60" | 500 | 16# |

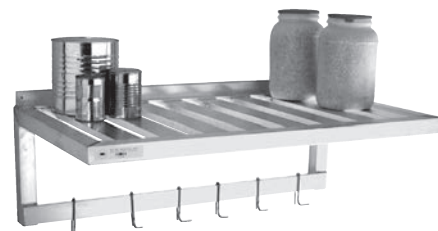

T-Bar Wall Shelf With Hanger and Hooks



T-Bar Wall Shelf



Solid Wall Shelf • H.D. & Standard



Inverted Shelf



"Quick Change" - Cantilever Shelving

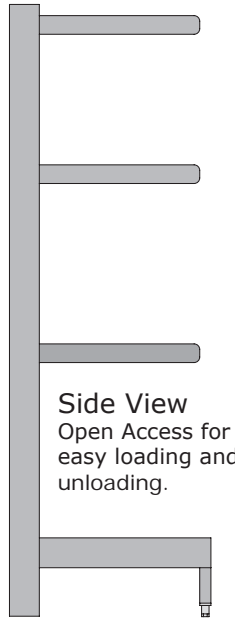

The above free-standing unit consists of the following:

- | | |
|----------------------|--|
| 1. H.D. Shelf (2) | 5. Common Upright (1) |
| 2. T-Bar Shelf (2) | 6. Left Upright (1) |
| 3. Solid Shelf (2) | 7. Horizontal Brace (2 pair) <i>Note: One pair required per shelving section.</i> |
| 4. Right Upright (1) | |

Ordering Instructions

- Determine the number of shelving sections in the shelving run - Find type, number, and depth of shelves required per section. **1, 2, 3**
- Add a pair of horizontal braces per shelving section. **7**
- Shelving sections 3', 4', and 5' long require two uprights, one left and one right. **4, 6**
- Run lengths over 5' require a left and right upright on the ends and a common upright between each section. (as shown in the picture above). **4, 5, 6**

Note

- Shelving runs are described in one foot increments. The actual length of a run is an additional 2-3/4", i.e. a typical 7' run is actually 7' 2-3/4" (86-3/4") long.

| Model No. | Size D-L | Wt. Cap. | Ship Wt. |
|-----------|----------|----------|----------|
|-----------|----------|----------|----------|

H.D. BAR SHELF

| | | | |
|-----------|----------------|-----------|-----|
| 2501..... | 18" x 36"..... | 900#..... | 7# |
| 2502..... | 18" x 42"..... | 900#..... | 8# |
| 2503..... | 18" x 48"..... | 900#..... | 8# |
| 2505..... | 18" x 60"..... | 900#..... | 10# |
| 2511..... | 24" x 36"..... | 900#..... | 8# |
| 2512..... | 24" x 42"..... | 900#..... | 8# |
| 2513..... | 24" x 48"..... | 900#..... | 9# |
| 2515..... | 24" x 60"..... | 900#..... | 11# |

Full radius front edge.

T-BAR SHELF

| | | | |
|-----------|----------------|-----------|-----|
| 2521..... | 18" x 36"..... | 900#..... | 10# |
| 2522..... | 18" x 42"..... | 900#..... | 11# |
| 2523..... | 18" x 48"..... | 900#..... | 12# |
| 2525..... | 18" x 60"..... | 900#..... | 14# |
| 2531..... | 24" x 36"..... | 900#..... | 11# |
| 2532..... | 24" x 42"..... | 900#..... | 12# |
| 2533..... | 24" x 48"..... | 900#..... | 14# |
| 2535..... | 24" x 60"..... | 900#..... | 17# |

Ideal for smaller product as well as heavier loads.

SOLID REINFORCED SHELF

| | | | |
|-----------|----------------|-----------|-----|
| 2541..... | 18" x 36"..... | 700#..... | 10# |
| 2542..... | 18" x 42"..... | 700#..... | 11# |
| 2543..... | 18" x 48"..... | 700#..... | 12# |
| 2545..... | 18" x 60"..... | 700#..... | 14# |
| 2551..... | 24" x 36"..... | 700#..... | 11# |
| 2552..... | 24" x 42"..... | 700#..... | 12# |
| 2553..... | 24" x 48"..... | 700#..... | 13# |
| 2555..... | 24" x 60"..... | 700#..... | 19# |

For smaller products and spill control.

| Model No. | Item Description | Ship Wt. |
|-----------|------------------|----------|
|-----------|------------------|----------|

HORIZONTAL BRACE — Free-Standing Units Only

| | | |
|-----------|-------------------------------|----|
| 2581..... | 36" Horizontal Brace (2)..... | 4# |
| 2582..... | 42" Horizontal Brace (2)..... | 4# |
| 2583..... | 48" Horizontal Brace (2)..... | 5# |
| 2585..... | 60" Horizontal Brace (2)..... | 7# |

FREE-STANDING UPRIGHTS — 72" in Height

| | | |
|-----------|---------------------------------------|-----|
| 2561..... | 21" Left Upright • 18" Shelves..... | 13# |
| 2563..... | 21" Right Upright • 18" Shelves..... | 13# |
| 2565..... | 21" Common Upright • 18" Shelves..... | 14# |
| 2571..... | 27" Left Upright • 24" Shelves..... | 14# |
| 2573..... | 27" Right Upright • 24" Shelves..... | 14# |
| 2575..... | 27" Common Upright • 24" Shelves..... | 15# |

Uprights have locking tabs spaced on 12" centers and an extended leg with adjustable foot.



"Quick Change" - Cantilever Shelving



H.D. Bar Shelf • 900# Wt. Capacity



T-Bar Shelf • 900# Wt. Capacity



Solid Brute Shelf • 700# Wt. Capacity



Wall/Ceiling Mounted Unit

Ordering Instructions

- Determine the number of shelving sections in the shelving run – Find type, number, and depth of shelves required per section.
- Horizontal braces are not needed.
- Shelving sections 3', 4', and 5' long require two uprights, one left and one right.
- Run lengths over 5' require a left and right upright on the ends and a common upright between each section. (as shown in the picture above).

Note

- Upright height (length) is determined by ceiling height.
- Actual shelf depth from the wall to the front of the shelf is 3" more than the listed shelf depth.
- The actual shelving run length is found by adding 6-1/2" to the sum of the shelf lengths in a shelving run – a typical 7' shelving run which uses a 36" shelf length and a 48" shelf length is actually 90-1/2" long (7' 6-1/2").

| Model No. | Item Description | Ship Wt. |
|--|---------------------|----------|
| WALL & CEILING MOUNTED UPRIGHTS | | |
| 95403 | 72" Left Upright | 9# |
| 95404 | 72" Right Upright | 9# |
| 95405 | 72" Common Upright | 10# |
| 97753 | 84" Left Upright | 11# |
| 97755 | 84" Right Upright | 11# |
| 97754 | 84" Common Upright | 12# |
| 95631 | 96" Left Upright | 13# |
| 95632 | 96" Right Upright | 13# |
| 95633 | 96" Common Upright | 14# |
| 96617 | 108" Left Upright | 15# |
| 96618 | 108" Right Upright | 15# |
| 96619 | 108" Common Upright | 16# |

Uprights have locking tabs spaced on 12" centers.



Stor-A-Shelf



"LIFT" the shelf up...



Line up the lip and the clip...



"CLICK" the shelf in place.



#97596

| Model No. | Size W-H-D | Wt. Cap. | Ship Wt. |
|--------------|---------------------------|------------|----------|
| °97596 | 37" x 52" x 60-1/4" | 500# | 102# |

Four 5" stem type casters (#C485).

- Units come knocked-down for freight savings.
- Multiple units nest for easy, compact storage.
- Roll and lock into place with locking casters.



Retractable Workstation



#98031

| Model No. | Size W-H-D | Shelf Size | Ship Wt. |
|-------------|----------------------------|---------------------------|----------|
| 98671 | 24" x 24" x 6-3/4" | 21-3/4" x 15-3/4" | 18# |
| 98031 ... | 60-1/4" x 39" x 6-3/4" ... | Top = 11-3/4" x 58" | 50# |
| | | Bottom = 16" x 58" | |

- Ideal for a receiving station!
- Comes fully assembled, ready to bolt to a wall.
- Shelves fold up and down to save space.
- Works great where temporary workstations are needed.
- Custom sizes available — call for quote.



#98671



Stainless Steel Top Tables



| Model No. | Size D-H-L | Ship Wt. | Model No. Undershelf | Ship Wt. |
|--|-----------------|----------|----------------------|----------|
| SOLID STAINLESS STEEL TOP (No Backsplash) | | | | |
| 24-SS-36KD | 24" x 34" x 36" | 45# | 24-US-36KD | 8# |
| 24-SS-48KD | 24" x 34" x 48" | 54# | 24-US-48KD | 11# |
| 24-SS-60KD | 24" x 34" x 60" | 63# | 24-US-60KD | 14# |
| 24-SS-72KD | 24" x 34" x 72" | 71# | 24-US-72KD | 16# |
| 24-SS-84KD | 24" x 34" x 84" | 79# | 24-US-84KD | 19# |
| 24-SS-96KD | 24" x 34" x 96" | 88# | 24-US-96KD | 22# |
| 30-SS-36KD | 30" x 34" x 36" | 51# | 30-US-36KD | 10# |
| 30-SS-48KD | 30" x 34" x 48" | 61# | 30-US-48KD | 13# |
| 30-SS-60KD | 30" x 34" x 60" | 71# | 30-US-60KD | 17# |
| 30-SS-72KD | 30" x 34" x 72" | 81# | 30-US-72KD | 20# |
| 30-SS-84KD | 30" x 34" x 84" | 91# | 30-US-84KD | 23# |
| 30-SS-96KD | 30" x 34" x 96" | 101# | 30-US-96KD | 27# |
| STAINLESS STEEL TOP WITH 6" BACKSPLASH | | | | |
| 24-SSB-36KD | 24" x 34" x 36" | 49# | 24-US-36KD | 8# |
| 24-SSB-48KD | 24" x 34" x 48" | 58# | 24-US-48KD | 11# |
| 24-SSB-60KD | 24" x 34" x 60" | 69# | 24-US-60KD | 14# |
| 24-SSB-72KD | 24" x 34" x 72" | 76# | 24-US-72KD | 16# |
| 24-SSB-84KD | 24" x 34" x 84" | 85# | 24-US-84KD | 19# |
| 24-SSB-96KD | 24" x 34" x 96" | 95# | 24-US-96KD | 22# |
| 30-SSB-36KD | 30" x 34" x 36" | 55# | 30-US-36KD | 10# |
| 30-SSB-48KD | 30" x 34" x 48" | 65# | 30-US-48KD | 13# |
| 30-SSB-60KD | 30" x 34" x 60" | 76# | 30-US-60KD | 17# |
| 30-SSB-72KD | 30" x 34" x 72" | 86# | 30-US-72KD | 20# |
| 30-SSB-84KD | 30" x 34" x 84" | 98# | 30-US-84KD | 23# |
| 30-SSB-96KD | 30" x 34" x 96" | 108# | 30-US-96KD | 27# |

- All the strength and durability of stainless steel at the cost of aluminum.
- Easy to clean top and frame.
- Units come with removable 16 G.A. type 304 stainless steel tops.
- Easily adjustable safety feet provide added stability and easy leveling.
- All models are shipped knocked down to reduce freight charges and damages.
- 36" Deep sizes are available
- Optional aluminum undershelves available for all models.
- Lifetime warranty against rust and corrosion.



Poly Top Tables



- All the strength and durability of stainless steel at the cost of aluminum.
- Easy to clean top and frame.
- Units have removable full 5/8" thick HDPE tops.
- Easily adjustable safety feet provide added stability and easy leveling.
- All models are shipped knocked down to reduce freight charges and damages.
- 36" Deep sizes are available – *Contact The Factory For Pricing.*
- Optional aluminum undershelves available for all models.
- Lifetime warranty against rust and corrosion.

| Model No. | Size D-H-L | Ship Wt. | Model No. Undershelf | Ship Wt. |
|---|-----------------|----------|----------------------|----------|
| SOLID POLY TOP (No Backsplash) | | | | |
| 24-P-36KD | 24" x 34" x 36" | 50# | 24-US-36KD | 8# |
| 24-P-48KD | 24" x 34" x 48" | 59# | 24-US-48KD | 11# |
| 24-P-60KD | 24" x 34" x 60" | 69# | 24-US-60KD | 14# |
| 24-P-72KD | 24" x 34" x 72" | 79# | 24-US-72KD | 16# |
| 24-P-84KD | 24" x 34" x 84" | 88# | 24-US-84KD | 19# |
| 24-P-96KD | 24" x 34" x 96" | 99# | 24-US-96KD | 22# |
| 30-P-36KD | 30" x 34" x 36" | 55# | 30-US-36KD | 10# |
| 30-P-48KD | 30" x 34" x 48" | 66# | 30-US-48KD | 13# |
| 30-P-60KD | 30" x 34" x 60" | 80# | 30-US-60KD | 17# |
| 30-P-72KD | 30" x 34" x 72" | 90# | 30-US-72KD | 20# |
| 30-P-84KD | 30" x 34" x 84" | 104# | 30-US-84KD | 23# |
| 30-P-96KD | 30" x 34" x 96" | 115# | 30-US-96KD | 27# |
| POLY TOP WITH 6" STAINLESS STEEL BACKSPASH | | | | |
| 24-PBS-36KD | 24" x 34" x 36" | 53# | 24-US-36KD | 8# |
| 24-PBS-48KD | 24" x 34" x 48" | 63# | 24-US-48KD | 11# |
| 24-PBS-60KD | 24" x 34" x 60" | 75# | 24-US-60KD | 14# |
| 24-PBS-72KD | 24" x 34" x 72" | 86# | 24-US-72KD | 16# |
| 24-PBS-84KD | 24" x 34" x 84" | 95# | 24-US-84KD | 19# |
| 24-PBS-96KD | 24" x 34" x 96" | 107# | 24-US-96KD | 22# |
| 30-PBS-36KD | 30" x 34" x 36" | 60# | 30-US-36KD | 10# |
| 30-PBS-48KD | 30" x 34" x 48" | 71# | 30-US-48KD | 13# |
| 30-PBS-60KD | 30" x 34" x 60" | 85# | 30-US-60KD | 17# |
| 30-PBS-72KD | 30" x 34" x 72" | 98# | 30-US-72KD | 20# |
| 30-PBS-84KD | 30" x 34" x 84" | 110# | 30-US-84KD | 23# |
| 30-PBS-96KD | 30" x 34" x 96" | 123# | 30-US-96KD | 27# |



Table Mount Cantilever Shelves

| Model No. | Item Description | Ship Wt. |
|-----------|---------------------------------------|----------|
| 99819 | 12" x 24" SS Shelf, Posts, & Brackets | 17# |
| 99820 | 12" x 24" SS Shelf | 11# |
| 99653 | 12" x 36" SS Shelf, Posts & Brackets | 25# |
| 99654 | 12" x 36" SS Shelf | 16# |
| 99821 | 12" x 48" SS Shelf, Posts & Brackets | 34# |
| 99822 | 12" x 48" SS Shelf | 22# |
| 99823 | 12" x 60" SS Shelf, Posts & Brackets | 43# |
| 99824 | 12" x 60" SS Shelf | 28# |
| 99825 | 12" x 72" SS Shelf, Posts & Brackets | 51# |
| 99826 | 12" x 72" SS Shelf | 37# |

- Adjustable cantilever stainless steel top shelves.
- 36" posts adjust to fit your height requirements.
- Stainless steel nesting shelf top with 1" backsplash is removable for easy cleaning.
- Heavy duty aluminum posts and shelf frames.
- Additional cantilever shelves can be added at any time.



#30SS36KD Table
#99653 SS Shelf, Posts & Bracket (kit)
#99654 SS Shelf (optional extra shelf)



Adjustable posts and shelves bolt easily to table mounting plate.

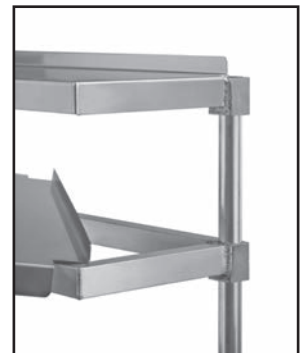

Removable stainless steel shelf top.



Table Accessories



Table Mount Organizer Rack

Organizer Rack Divider

Paper Holder

Backsplash

Drawer

Undershelf (pg 50-51)

| Model No. | Item Description | Size | Ship Wt. |
|--------------------------|--|----------------|----------|
| TABLE ACCESSORIES | | | |
| 1375..... | Paper Holder..... | 12" x 5" x 31" | 3# |
| 1376..... | Platter Holder..... | 30" x 24" | 5# |
| 1377..... | Drawer/Hardware..... | 15" x 18" | 10# |
| 1379..... | S.S. Backsplash 6" x 6"..... | 36" | 9# |
| 1380..... | S.S. Backsplash 6" x 6"..... | 48" | 11# |
| 1381..... | S.S. Backsplash 6" x 6"..... | 60" | 14# |
| 1382..... | S.S. Backsplash 6" x 6"..... | 72" | 17# |
| 1383..... | S.S. Backsplash 6" x 6"..... | 84" | 19# |
| 1384..... | S.S. Backsplash 6" x 6"..... | 96" | 22# |
| 999..... | (4) Casters, 5" Stem Type For KD Tables..... | | 8# |

#1376 Fits 30" wide tables only

Note: Casters Are Factory Installed Only



Packaging Rack/Organizer

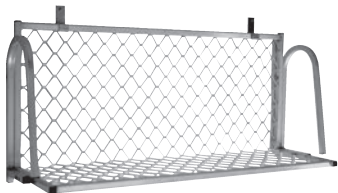

Wall Mount Organizer

- Structural aluminum mesh creates back and base.
- Allows easy cleaning.



Ceiling Mount Organizer - "L"

- Structural aluminum mesh with "L" type shelf, vertically adjustable telescoping mount.



Ceiling Mount Organizer - "T"

- Structural aluminum mesh with "T" type shelf, vertically adjustable telescoping mount.
- Storage on front and back of unit.

| Model No. | Size D-H-L | Ship Wt. |
|-----------|------------|----------|
|-----------|------------|----------|

TABLE MOUNT ORGANIZER RACKS

| | | |
|------------|----------------------|-----|
| 120T..... | 15" x 21-1/4" x 36" | 18# |
| 1371T..... | 15" x 21-1/4" x 48" | 21# |
| 1372T..... | 15" x 21-1/4" x 60" | 24# |
| 1373T..... | 15" x 21-1/4" x 72" | 25# |
| 1374T..... | 15" x 21-1/4" x 96" | 32# |
| 1375T..... | 15" x 21-1/4" x 120" | 36# |

WALL MOUNT ORGANIZER RACKS

| | | |
|------------|----------------------|-----|
| 120W..... | 15" x 21-1/4" x 36" | 15# |
| 1371W..... | 15" x 21-1/4" x 48" | 18# |
| 1372W..... | 15" x 21-1/4" x 60" | 21# |
| 1373W..... | 15" x 21-1/4" x 72" | 23# |
| 1374W..... | 15" x 21-1/4" x 96" | 27# |
| 1375W..... | 15" x 21-1/4" x 120" | 31# |

CEILING MOUNT ORGANIZER RACKS - "L" TYPE

| | | |
|-------------|---------------------|-----|
| 1373CL..... | 15" x 21-1/4" x 72" | 25# |
| 1374CL..... | 15" x 21-1/4" x 96" | 27# |

CEILING MOUNT ORGANIZER RACKS - "T" TYPE

| | | |
|-------------|---------------------|-----|
| 1373CT..... | 29" x 21-1/4" x 72" | 32# |
| 1374CT..... | 29" x 21-1/4" x 96" | 38# |

All Organizers Include Mounting Brackets.

OPTIONS:

#1378 Organizer Rack Divider.



Aluminum Cove Baseboard

| Model No. | Length | Height |
|------------|--------|--------|
| 9787C..... | 96" | 5" |

- Solid anodized aluminum keeps its good looks and cleans up with just soap and water.
- Use instead of quarry tile or vinyl.
- Due to its natural propensity to ward off rust and corrosion, this baseboard is perfect for any type of atmosphere.
- Easy to install.

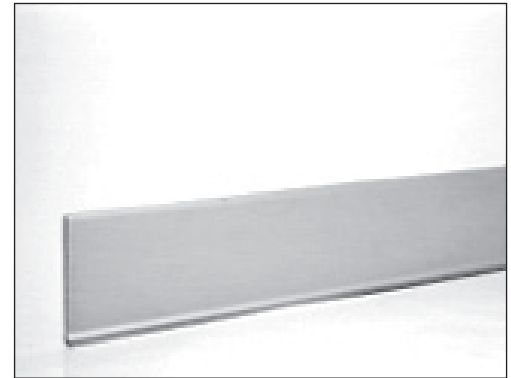
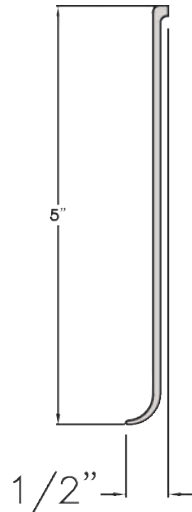

#9787C

Aluminum Subway Grating

| Model No. | Width | Wt. (lineal ft.) |
|------------|-------|------------------|
| ASG12..... | 12" | 4# |
| ASG15..... | 15" | 6# |
| ASG18..... | 18" | 7# |
| ASG21..... | 21" | 8# |
| ASG24..... | 24" | 9# |

SOLD PER LINEAL FOOT.

Construction: These units are fabricated from all-welded aluminum. The vertical bars are 1/4" thick, 1" high, spaced on 1" centers (3/4" between bars); support rods 1/16" diameter, spaced 3" from each end (widths over 12" require a third support rod which is centered). **Maximum length per section is 18".**

Additional Sizes Available

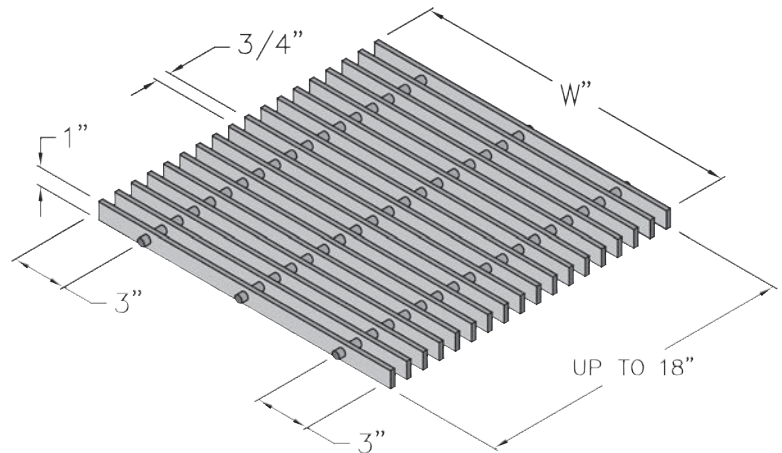

Corner Guards

| Model No. | Length | Ship Wt. |
|--------------------------|--------|----------|
| 2" x 2" WINGS 90° | | |
| 97873..... | 36" | 1.5# |
| 97874..... | 48" | 1.9# |
| 97875..... | 60" | 2.3# |
| 97876..... | 72" | 2.75# |
| 3" x 3" WINGS 90° | | |
| 97877..... | 36" | 1.9# |
| 97878..... | 48" | 2.5# |
| 97879..... | 60" | 3# |
| 97880..... | 72" | 3.6# |

.080" Thick Aluminum Sheet.

- Can be used as an inside or outside protector.
- Easy to install.



Aluminum Security Fence

Units Are Mounted To The Floor *and* The Ceiling



- Will not corrode like wire fencing.
- Additional Locking Options Available

Standard units are those that fall between these parameters, with a center door:

Width = 68" - 116"
Height = 88" - 110"

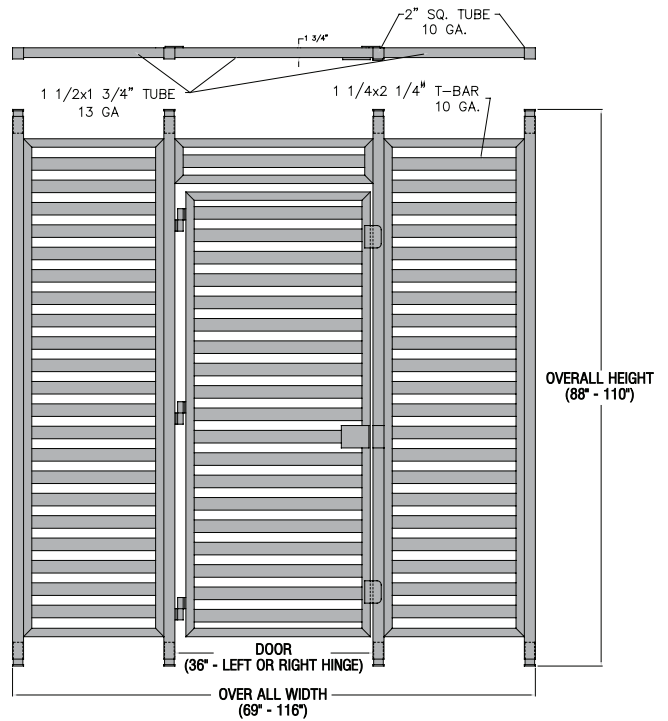

Each fence needs a custom quote. When requesting a Security Fence, we need the **WIDTH & HEIGHT** of the opening for the fence along with the **HINGE POSITION** (left or right). If there are special conditions such as a Ceiling Mounted Condenser or some other object that would require the fence to be modified, we need these dimensions to quote the fence.



Mat Cart



#99360

| Model No. | Size W-H-D | Wt. Cap. | Ship Wt. |
|-----------|------------|----------|----------|
|-----------|------------|----------|----------|

99360..... 41-1/2" x 40" x 27-1/2".....500#.....40#

Four 5" plate type casters -
 two swivel (#C450), two swivel with brake (#C455).

- Labor saving mobile mat carts keep mats off of the floor for easy, efficient cleaning.
- Hooks secure perforated mats for storage and cleaning.
- Center horizontal bars hold solid mats.
- Ideal for power washing mats on the cart.
- Lifetime warranty against rust and corrosion.



Aluminum Security Cage

| Model No. | Size W-H-D | Interior Shelves | Shelf Size | Clear Space | Lock Type | Ship Wt. |
|--|-----------------------------|------------------|-------------------|-------------|---------------------|----------|
| MOBILE SECURITY CAGE | | | | | | |
| 97621 | 49" x 71" x 26-3/4" | 3 | 23-1/2" x 45-3/4" | 19" | Hasp | 170# |
| Equipped with four, 5" plate type casters (#C450). | | | | | | |
| 99475 | 49" x 68-3/4" x 26-3/4" | 3 | 23" x 45-3/4" | 18" | Hasp | 257# |
| Equipped with four 8" plate type pneumatic casters - two rigid (#C516), two swivel (#C519) | | | | | | |
| 99814 | 57-1/4" x 74-1/2" x 28-1/4" | 4 | 24-1/2" x 52" | 14-1/4" | Top Latch with Hasp | 376# |
| Equipped with four 8" plate polyurethane type casters - one rigid(#C527), one rigid w/ brake (#C528), one swivel (#C526), one swivel w/ brake (#421) | | | | | | |
| STATIONARY SECURITY CAGE | | | | | | |
| 97846 | 48" x 72" x 24" | 4 | 22" x 45" | 14" | Hasp | 155# |
| Equipped with four adjustable feet (#0117). | | | | | | |
| SOLID SECURITY CAGE | | | | | | |
| 98167 | 49" x 72" x 26" | 3 | 24" x 45" | 19" | Lever | 190# |
| Equipped with four, 5" plate type casters (#C450). | | | | | | |
| 99551 | 37-1/4" x 73" x 26" | 4 | 22-1/2" x 35" | Adj. | Hasp | 250# |
| Equipped with four, 5" x 2" casters- two rigid (#C463), two swivel w/ brake (#C462). | | | | | | |

OPTIONS:

"PP(A)" - see page 63 for details.

- Provides safe, lockable security of valuable and/or dangerous materials.
 - Ideal "emergency box" for schools
 - Use for chemical storage
- Equipped with double doors with a stainless steel hasp and replaceable stainless steel hinges.
- All welded aluminum construction.
- Lifetime warranty against rust and corrosion.



#97621



#99475



#97846



#99814



#99551



#98167

